

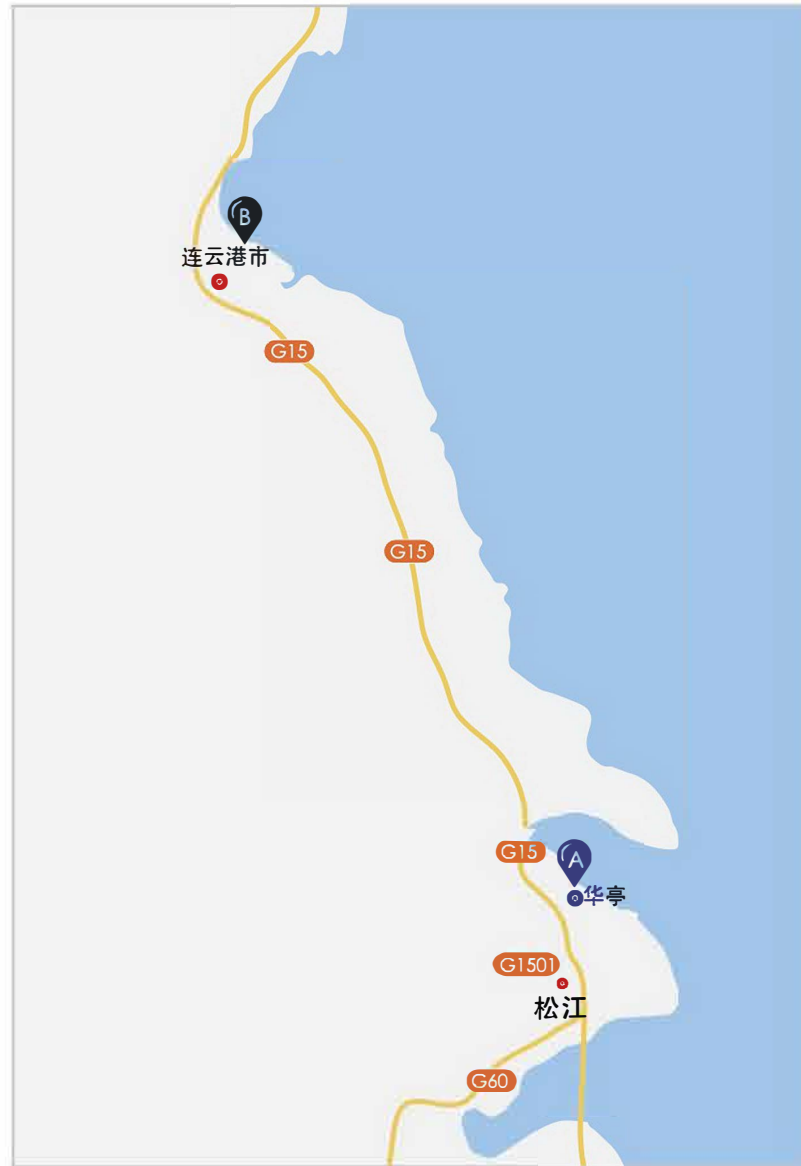

Join my WeChat

All rivers flow into the sea, Mount Kunlun is top in the sky
Great virtue can carry all things, Truth-seeking and innovative



BAILUN SHANGHAI FACTORY

Address: Building 3, No.28 Huojiao Road, Songjiang, Shanghai
Tel : 021-67867376 +86-13968006641
E-Mail: info@bailunbio.cn
Web: www.bailunbioreactor.com / bailunbio.cn

BAILUN BIOTECH (JIANGSU) CO.,LTD

Address: No. 3 Liongong Road, Lingong Automatic Control Equipment
Industrial Zone, Dunshong Town, Gonyu District, Lionyungong
Tel: 0518-85215152 +86-13968006641
E-mail: info@bailunbio.cn
Web: www.bailunbioreactor.com/bailunb10.cn

2023



LABORATORY SERIES

www.bailunbioreactor.com
www.bailunbio.cn

- **2008** Shanghai Bailun Biological Technology Co., Ltd.
- **2009** Lianyungang Bailun Biochemical Technology Co., Ltd.
- **2017** Lianyungang Bailun Bioreactor Technology Co., Ltd.
- **2021** Bailun Biotechnology (Jiangsu) Co., Ltd.
- Current Bailun has more than 20,000 sets of equipment in more than 90 countries and regions around the world stable operation, continue to create value for users!



COMPANY PROFILE

Bailun Biotechnology (Jiangsu) Co., Ltd. is a leading supplier of intelligent data-driven bioreactor systems in China. Products cover all kinds of bioreactors in laboratory, pilot scale and industrial production, including fermenter, animal cell bioreactor, plant cell bioreactor, single-use bioreactor, liquid dispensing system and disposable reactor, etc. Can produce bioreactor of 0.1L-1000KL volume and technical services, and provide intelligent and personalized comprehensive solutions for bioreactors process. Bailun has a large number of experienced fermentation process, biochemical equipment and chemical technical engineers, many famous experts and scholars as the company's technical consultants,. Bailun forever pursuits to create value for customers, and adhere to customer-centric is the core value of Bailun.

In order to optimize and enlarge the production of process products in biological processes, various problems in the process need to be studied, therefore, a variety of research instruments and equipment are designed, and various conclusions are obtained through experiments and used in production practice. This equipment for the study of biological processes can be divided into seed material studies of living cells with the main objective of synthetic biology, and problems arising from changes in the transfer characteristics of process mixing, for which various bioreactor devices have been formed. To this end, the company to the above content as the goal, combined with the actual situation of users organized a series of devices for research products. Among them, there are products for high performance cell line acquisition device, biological reactor products for obtaining bacterial physiological characteristics, experimental equipment for biological process optimization and amplification, bioreactor system for intelligent biological process, as well as a variety of measurement, sterilization or sampling manual operation, data processing software packages, GMP operating characteristics and other components research products for users to choose.

Bailun Spirit:

Customer foremost, seeking quality, fairness and honesty, continuous improvement!



BAILUN QUALIFICATION

Honor exists because of customers: because all our efforts are for the satisfaction of customers. Honor is the affirmation, trust and spur, honor is our golden card and pass, honor is our signpost and a journey, Honor represents the past. Bailun people regard honor as an inexhaustible motivation to encourage their own continuous improvement and progress.

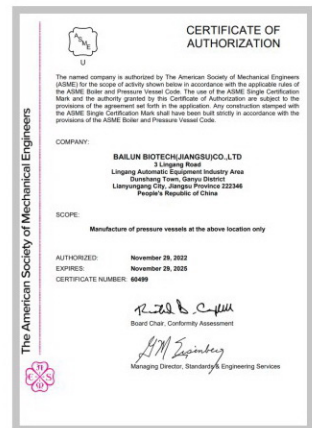
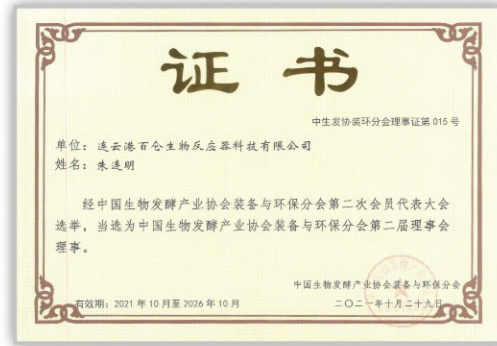

First-class quality, from the innovation of technology!

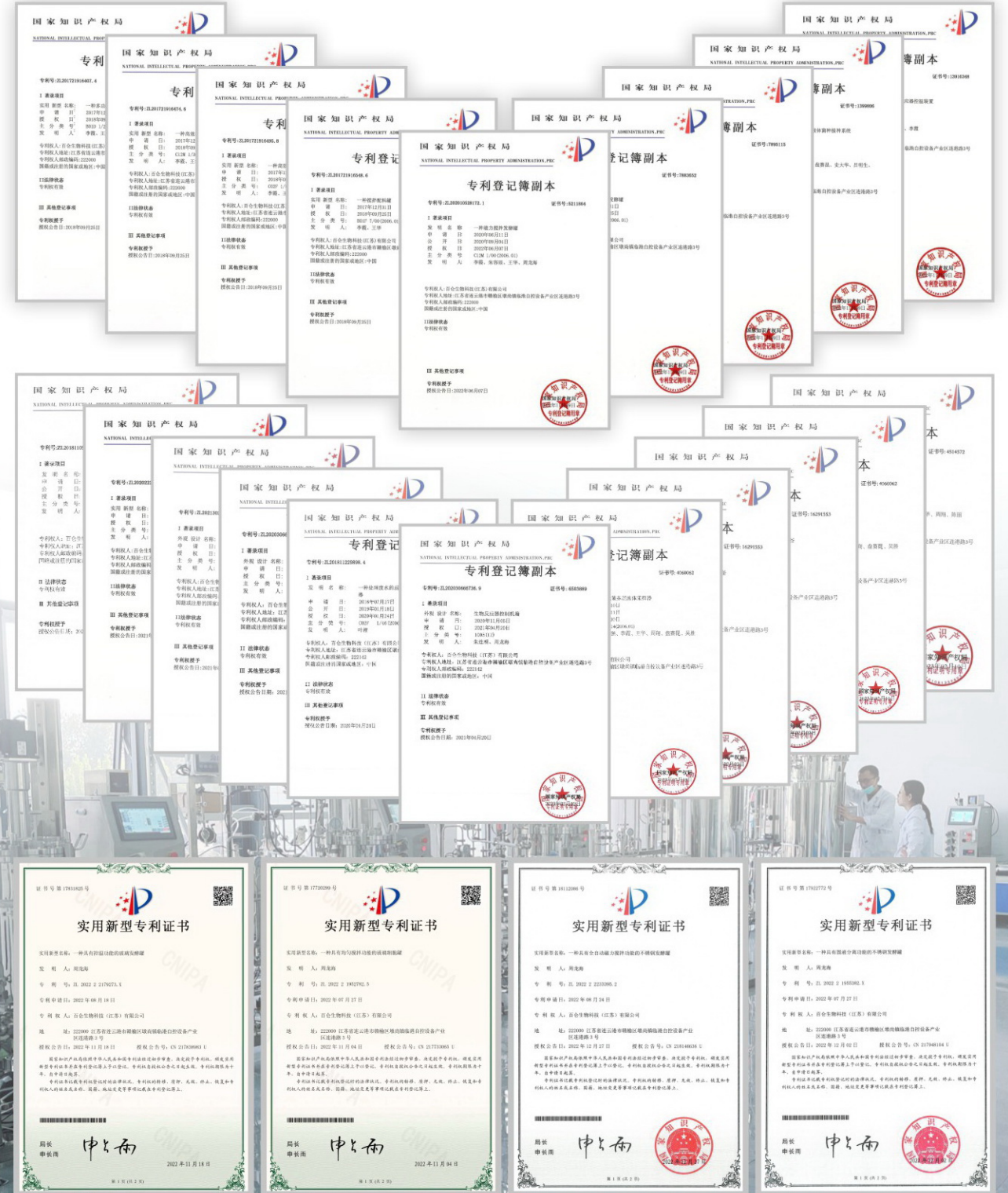

GLASS BIOREACTOR

Off-site sterilization glass fermenter

Suitable for the cultivation of microbial yeast and fungi, ready to use, easy to operate, easy to learn and use, and extremely low failure rate.

- After suitable fittings are installed, it can be suitable for culture of cells of mammals and insects.
- The semi-circular stainless steel jacket bottom, built-in heat exchanger and serial inner heat exchange baffle are conducive to temperature control of hot/cold water and fast heat transfer.
- Tanks working volumes as 1L, 2L,3L, 5L, 7L,10L 15L,20L,30L,40L and 50L are available for selection. Culture tanks are interchangeable.



BLBIO-5GC Off-site sterilization magnetic driving glass fermenter (magnetic stirring fermenter)

Magnetic driving is suitable for products that have high requirements for biological safety with low culture medium viscosity and long fermentation cycle.



BLBIO-5GJ Off-site sterilization shaft driving glass fermenter (mechanical stirring fermenter)

The shaft driving is suitable for culture of high-density, high-viscosity, and high-oxygen consumption. It has strong universality.

The bioreactor device for obtaining the physiological characteristics of strains is to obtain the cells obtained from high-performance cell or shake flasks in conventional fermenters (such as only temperature, rotation speed, aeration, pH, DO, etc.) Basic physiological properties.

Full glass tank, good integral structure, safe and reliable, convenient use, easy to learn and to use.

- Tank with working volumes 2L, 3L, 5L, 7L, 10L, 15L and 20L are available for selection, and the culture tanks are interchangeable.
- As for the ventilation optional, it can be equipped with the mass flow meter to reinforce the function and increase the oxygen enrichment bypass function.



BLBIO-XGJG glass fermenter (single-wall tank)

Single-wall glass fermenter control temperature by external electric heating blanket and inner dipping cooling coil, easy and convenient, low fault rate.



BLBIO-XGJGG glass fermenter (double-wall glass tank)

Temperature control by jacket glass tank, stainless steel water tank and heater, circulating pump forced circulation temperature control, accurate temperature control. The shortage is slightly heavy, the jacket glass is easy broken and easy damaged, And the culture medium sterilization time is slightly long.



BLBIO-5GJ-plus Off-site sterilization shaft driving glass fermenter (mechanical stirring fermenter)

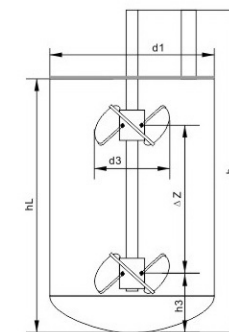

Specification name	1L	2L	3L	5L	7L	10L	15L	20L	30L	40L
Total volume (L)	1L	2L	3L	5L	7L	10L	15L	20L	30L	40L
Working volume (L)	0.7L	1.4L	2.1L	3.5L	4.9L	7L	10.5L	14L	21L	28L
Bioreactor diameter d1(mm)	90	120	140	160	190	214	214	256	282	342
Bioreactor height h(mm)	155	228	240	265	318	325	423	432	520	454
h/d1	1.7	1.9	2	1.65	1.67	1.5	1.97	1.68	1.84	1.3
Filling height hL [mm] Filling liquid volume	116	171	180	200	238.5	244	317	304	358	323
d2,3 Paddle (mm)	50	60	70	85	95	108	108	128	141	171
d2,6 Paddle (mm)	/	/	/	/	/	/	/	/	/	/
h3(mm)	40	65	42	62	76	80	80	102	113	137
$\Delta z=1.3 \times d2$, (3-blade segment impeller) (mm)	/	78	91	110	124	140	140	166	183	222

MULTI-CHANNEL MINI PARALLEL BIOREACTOR

— Obtain high-performance cell reactor device

The strains are transformed by natural mutagenesis, mutation breeding or synthetic biology, and high-throughput screening is used to obtain high-performance cell. High-throughput screening generally uses high-throughput microplate screening methods and microreactor studies. We use the multi-channel mini-parallel bioreactor with volume of 0.1-2.4 liters. Due to the smooth characteristics of the microreactor, it is more suitable for industrial production devices and has better results. (The multi-channel here is to obtain a few high-performance cell from a large number of cells)

- Optional working volumes as 0.1, 0.3L, 0.5L, 0.6L, 0.7L, 1L, 2L, and 2.4L are available for selection. Culture tanks are interchangeable.
- Two ways of water temperature control and no water temperature control are available for selection
- Temperature control with water or without water can be selected



BLBIO-0.2GJ-mini 0.2L mechanical mixing glass bioreactor



BLBIO-1GJ-4-mini 1L quadruple multi-channel micro-bioreactor



BLBIO-0.5GJ-4-mini 0.5L quadruple mechanical mixing multi-channel micro-bioreactor



BLBIO-1GJ-4-H-mini 1L quadruple mechanical mixing multi-channel micro-bioreactor



BLBIO-0.5GJ-12-mini 0.5L duodecuple mechanical mixing micro-bioreactor
The best choice for strain screening, quadruple, octuple and duodecuple can be combined arbitrarily, occupying a small space



BLBIO-1GC-5-mini 1L quintuple magnetic multi-channel parallel bioreactor

DATA SCIENCE

Data Amplification Analysis Software

Mainly to address the properties of genes, cells and reactors in biological processes, In the process of multi-scale analysis, the restrictive conditions of the process can be distinguished, the influence of the mixed transfer characteristics of the process on cell metabolism can be known, and the process optimization and amplification can be realized.

Rapid discovery of key parameters and critical control points in vitamin fermentation.

Such as the discovery of oxygen regulation in vitamin fermentation, accurate process optimization and amplification.

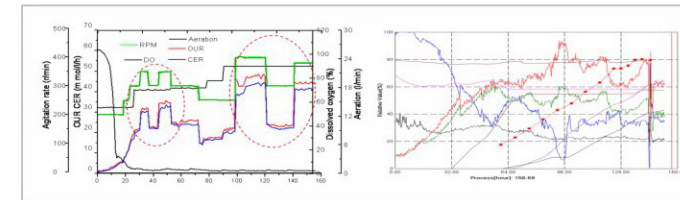

Multi-tanks real-time data collection by group with one key

In one software interface, the batch number data management of multiple fermentation tanks can be realized, and the batch numbers of multiple tanks can be established and real-time data can be collected with only one key.

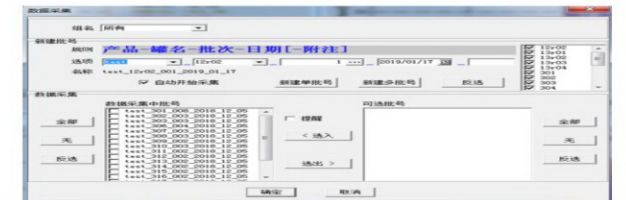

The optimal sugar and nitrogen feeding strategy of antimicrobial peptides

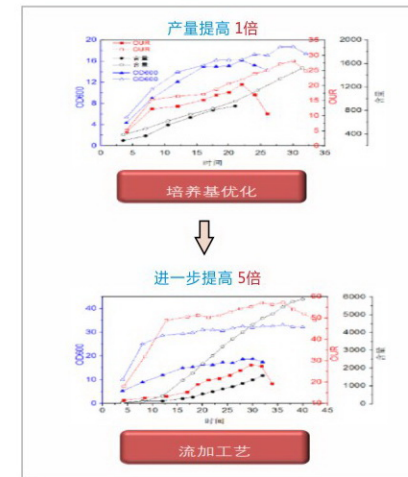

Quick docking of various types of parameters

Manage data such as real-time acquisition, manual measurement, intracellular metabolism, cell morphology and event recording, these data can be used comprehensively to calculate OUR, CER, RQ, Kla, cell specific production rate, substrate specific consumption rate and product specific production rate and other parameters that characterize the metabolic state, significantly improves the effectiveness and reliability of process optimization and scale-up.

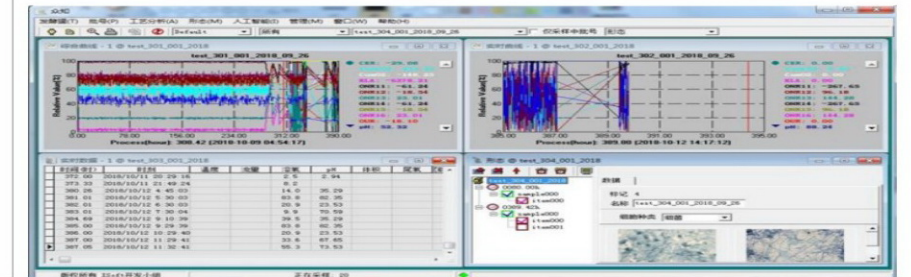

DOE Experimental Design

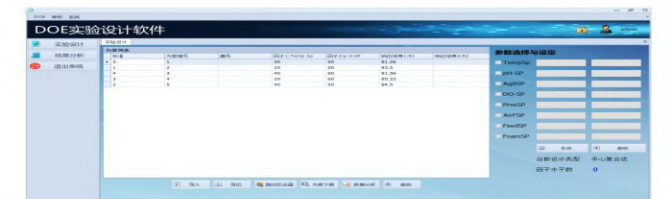
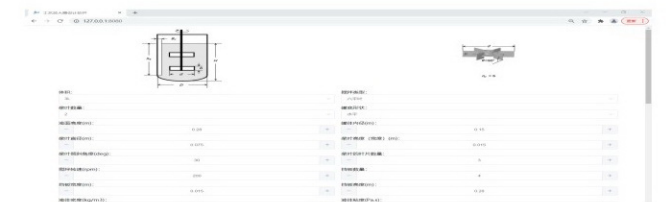
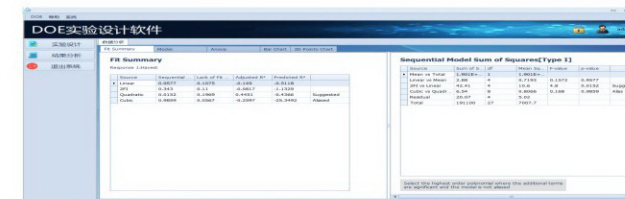
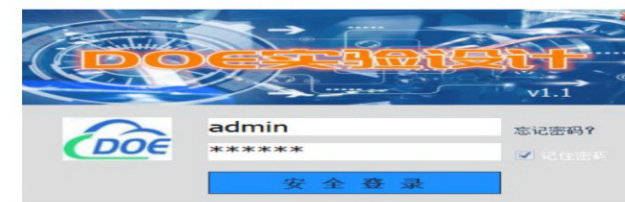

MULTI-CHANNEL PARALLEL GLASS BIOREACTOR

We have the following personalized upgrade services (charges apply): Data sharing system, intelligent software package, cloud service-related software, online scale-up design software, CFD fluid simulation, DOE experimental design, combined application of upstream synthetic biology research and fermentation engineering, and industrial scale-up, etc.

Double Parallel Glass Fermenter (desktop)

A standard model of desk type double bioreactors, a preferred product for strain screening and process research and development. High performance-price ratio, small floor space, convenient use, ready to use.



BLBIO-XGJ-2-A Double mechanical mixing glass fermenter (desktop)



BLBIO-XGC-2-A Double magnetic mixing glass fermenter (desktop)



BLBIO-XGJG-2-A Double mechanical mixing single wall glass fermenter (desktop)



BLBIO-XGJG-2-A Double mechanical mixing double wall glass fermenter (desktop)

Name	Double magnetic mixing glass fermenter (desktop)	Double mechanical mixing glass fermenter (desktop)	Double mechanical mixing all glass fermenter (desktop)
Model	BLBIO-XGC-2-A	BLBIO-XGJ-2-A	BLBIO-XGJG-2-A
Total volume (L)	0.5/0.6/0.7/0.8/1/2/3/5/7/10/15/20		
Material	Stainless steel + borosilicate glass		
Driving method	Bottom magnetic coupling drives mechanical stirring	Top shaft coupling drive mechanical stirring	Top shaft coupling drive mechanical stirring
Sterilization method	Autoclave off-site sterilization		
Base configuration	Temperature, speed, PH, DO, feed, defoaming, air flow (manual), tank pressure (manual)		
Extensible configuration (options)	Liquid level control, feeding weighing system, two-way feeding, online content detection of methanol and ethanol, exhaust O2 and CO2 detection, etc.		
Others	Power 220V 2KW	Dimension (L*W*H mm) 800*600*650	Net weight (kg)80

Quadruple Glass Bioreactor (off-site Sterilization)

It is a model of orthogonal parallel contrast reactor, a sharp tool for screening of medium formula and process optimization.

- Power consumption: 220V 8KW
- Dimensions (L*W*H mm): 1600*730*1750
- Material: 316L stainless steel + borosilicate glass
- Net weight(kg): 150
- Sterilization method: autoclave off-site sterilization
- Total volume: 1/2/3/5/7/10/15L



BLBIO-XGC-4-H Quadruple magnetic mixing glass fermenter (5L)



BLBIO-XGJ-4-H Quadruple mechanical mixing glass fermenter (5L)



BLBIO-XGJG-4-H Quadruple mechanical mixing single wall glass fermenter (5L)



BLBIO-XGJGG-4-H Quadruple mechanical mixing double wall glass fermenter (2L 3L 4L 5L)

MULTI-CHANNEL PARALLEL GLASS BIOREACTOR

Multi-channel parallel bioreactor for Metabolic flow analysis

It is suitable for initial strain screening, which greatly saves time and material costs, and positive and negative cross-parallel comparisons (strain screening).



BLBIO-XGC-4-plus Quadruple mechanical mixing glass fermenter (500mL)



BLBIO-XGC-4-plus Quadruple magnetic mixing glass fermenter (5L)



BLBIO-XGJ-4-plus Quadruple mechanical mixing glass fermenter (5L)



BLBIO-XGJ-11-plus Elevenfold mechanical mixing glass fermenter (5L)

Name	Quadruple magnetic mixing glass fermenter	Quadruple mechanical mixing glass fermenter	Quadruple mechanical mixing glass fermenter
Model	BLBIO-XGC-4-plus	BLBIO-XGC-4-plus	BLBIO-XGJ-4-plus
Driving method	Bottom magnetic drive mechanical stirring	Top shaft coupling drive mechanical stirring	Top shaft coupling drive mechanical stirring
Total volume	1/2/3/5/7/10/15L		
Base configuration	Temperature, mix speed, pH, DO, feeding, defoaming, air flow (manual), tank pressure (manual)		
Power consumption	220V 4KW	220V 5KW	220V 5KW
Dimension (L*W*H)(mm)	1200*730*1650	2000*730*1650	2000*730*1650
Weight (kg)	100	200	200

Multiple Glass Bioreactors (6-12 Units, Off-site Sterilization)

Simple structure, convenient operation, improved efficacy



BLBIO-XGJGG-6 Sextuple double wall glass fermenter (2L)



BLBIO-XGJGG-6 Sextuple double wall glass fermenter (5L)



BLBIO-XGJ-8-H Octuple mechanical mixing glass fermenter (1L)



BLBIO-XGJ-10-H Decuple magnetic mixing glass fermenter (1L)

BIOPROCESS OPTIMIZATION AND SCALE-UP BIOREACTORS

By understanding bacterial physiology and understanding the effects of process mixing transfer properties on cellular metabolism. Disciplines include synthetic biology, chemical engineering and the resulting biochemical engineering. In terms of methods, such as the application of process multi-scale correlation analysis, etc.

Top Mechanical Mixing Stainless Steel Fermenter

Simple structure, convenient operation, low failure rate, classic product of laboratory bioreactor



BLBIO-30SJA 30L Top mechanical mixing stainless steel fermentation system



BLBIO-100SJA 100L Top mechanical mixing stainless steel fermentation system



BLBIO-30SJA - 300SJA 30L - 300L Top mechanical mixing stainless steel fermentation system

Bottom Mechanical Mixing Stainless Steel Fermenter

Double mechanical sealing, steam sterilization, steam condensate cooling and lubrication



BLBIO-200SJBA 200L Bottom mechanical mixing stainless steel fermentation system



BLBIO-2000SJBA 2000L Bottom mechanical mixing stainless steel fermentation system



BLBIO-300SJBA - 3000SJBA 300L - 3000L Bottom mechanical mixing stainless steel fermentation system

BIOPROCESS OPTIMIZATION AND SCALE-UP BIOREACTORS

The bioreactor used for process research uses PHA's sensing technology and data analysis to explain the problem of multi-scale concept—which state analysis is the most important.

Top Magnetic Mixing Stainless Steel Fermenter

Without mechanical sealing, internal magnetic and upper and lower bearings can be CIP/SIP, which meets sanitary requirements.

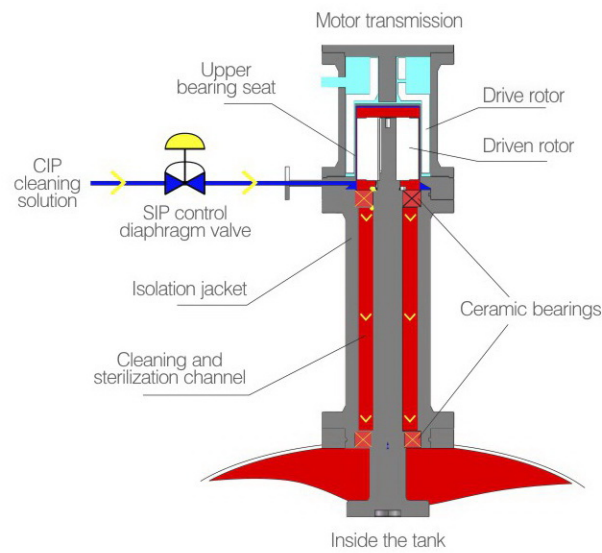

CIP/SIP process diagram



Top magnetic mixing cleaning



70L-1500L Top magnetic mixing bioreactor



50L-800L Top magnetic mixing bioreactor

Bottom Magnetic Mixing (upper Suspension) Stainless Steel Fermenter

No mechanical seal, easy to disassemble, suitable for long-term and vulnerable bacterial cultivation

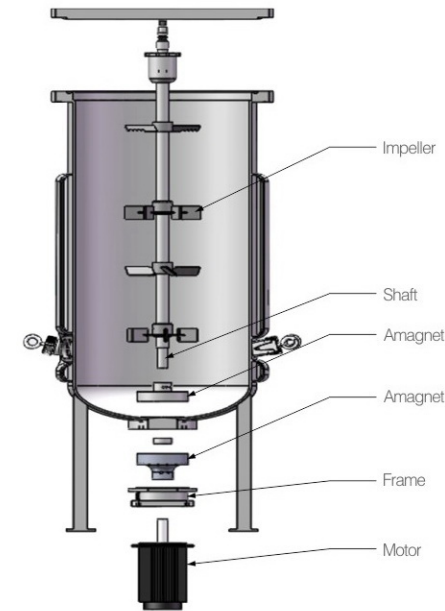

BLBIO-30SC-150SC 30L, 150L
Magnetic mixing secondary fermentation system



BLBIO-50SC 50L
Bottom magnetic mixing fermentation system



30L Bottom magnetic mixing bioreactor

MULTI-STAGE BIOREACTION SYSTEM

— Bioreactor systems for bioprocess intelligence

The variation of bacterial cells and the influence of changes in environmental conditions on cell metabolism are the main effects of changes in biological processes. Due to our lack of experimental conditions and incomplete understanding, it is impossible to explain the correlation between omics research in synthetic biology and fermentation regulation. Through the design and operation of the reactor, we combine the disciplines of synthetic biology, chemical engineering and biochemical engineering to solve the data sharing problem of the HCPs ternary system, solve the connection between artificial intelligence and biological processes, and form the interaction between human and artificial intelligence, to improve the ability to solve biological process problems. These include the study of cell dynamics in different environments, the resolution of various problems encountered in industrial production, such as the relationship between industrial production raw materials, equipment capabilities and processes, continuous and semi-continuous fermentation, data sharing of different batches, etc. Impact on industrialization through omics research and reverse reasoning research of fermented data silos.



BLBIO-10SJA-100SJA 10L-100L
Secondary Fermentation System



BLBIO-10SJA-10SJA-100SJA 10L-10L-100L
Double secondary fermentation system



BLBIO-5GJ-50SJ 5L-50L
Secondary Fermentation System



BLBIO-10SJA-50SJA 10L-50L
Secondary Fermentation System



BLBIO-10SJDU-100SJDU-500SJDU 10L-100L-500L
Three stage fermentation system



BLBIO-100SJA-100SJA-1000SJA 100L-100L-1000L
Double secondary fermentation system

MULTIPLE BIOREACTOR SYSTEM

Stable, concise, accurate, efficient, and a sharp tool for process research and development

The compact design and flexible configuration of the multi-channel bioreactor are suitable for exploring parameter conditions and optimizing the cultivation process. The control system is easy to operate and enables rapid data analysis. Equipment configurations can be customized, upgraded or expanded to meet the requirements of different applications, thereby improving experimental efficiency.

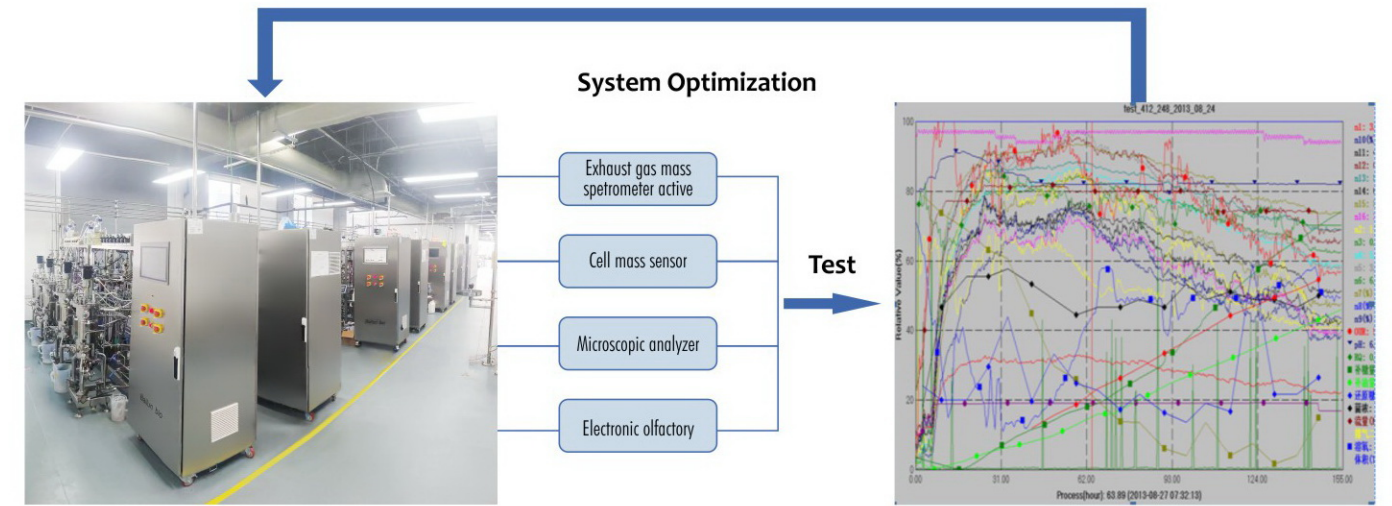

PHA Fermentation process

Advanced Sensing Technology

Dynamic changes in process state



METABOLIC FLUX ADVANCED BIOREACTION SYSTEM

Consistent with the highest configuration in Europe, it reduces the interference of human factors on scientific research, improves the repeatability and accuracy of data, reduces the cost of labor and materials, does not require a special person to be on duty, and can realize computer remote control and wireless monitoring. The tank lid automatic opening system, all parameters can be controlled automatically.

- 50L-100L as seed tan, unify seed standards.
- 4 to 16 units 5-10L tanks with the same geometric size for simultaneous differential culture.
- More than 17 direct parameters and related indirect parameters are measured for data summary and report analysis.



BLBIO-20SJA-FMT 20L
Metabolic flow automatic bioreactor system



BLBIO-30SJA-FMT 30L
Metabolic flow automatic bioreactor system



BLBIO-10SJ-3FMT 10L
Triple metabolic flow automatic bioreactor system



BLBIO-5GJ-4FMT 5L
Quadruple metabolic flow automatic bioreactor system

DATA SCIENCE

Bailun Huishen Multi-scale Analysis Software (1)

Bailun Huishen can provide curve comparison of multiple batches of the same parameters or different parameters, can directly detect temperature, rotation speed, air flow, tank pressure, PH, DO, defoaming, fermentation broth weight, two feeding amounts, exhaust O₂, CO₂ online accurate calculation can get OUR, CER reflecting the change of cell metabolic flow, RQ, KLA and other indirect parameters.

- Parallel system consisting of 4-16 tanks:
- The whole assembly consists of (1) reactor group and control hardware and software; (2) data transfer and intelligent software package;
- (3) cloud service and remote analysis.



1. Perfect data integration capabilities

This software can integrate the flow data (on-line) collected by the central control system and different online instruments independent of the central control system, and has the ability to integrate offline (off-line) data (including pictures, offline measurement data, production and development process exception records, etc.) and the ability to perfectly integrate online data.

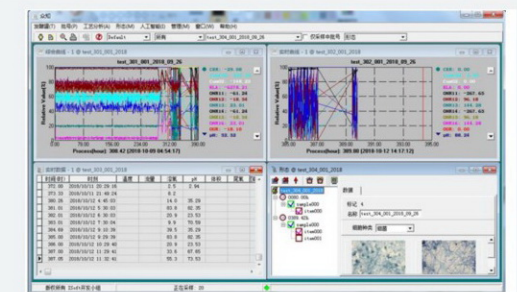

2. Powerful data display function:

This software can display online and offline data from different sources in one online real-time graph (including offline data display) after standardized calculation and processing. It is capable of deepening and coloring key parameter (data) curves, emphasizing the ability to monitor and compare key parameters in the process.

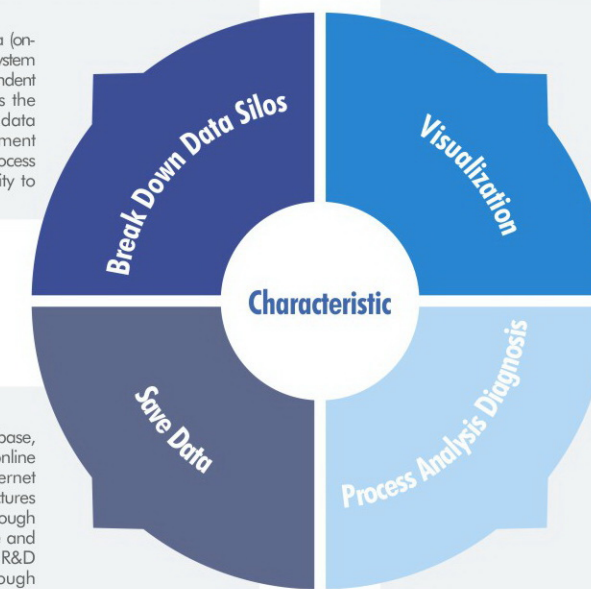

3. Persistent data storage capacity

This software has an independent database, which can directly transmit and store online data on different devices through Internet communication. Offline data and pictures can be imported into the database through manual operations to ensure complete and effective storage of production and R&D data. Long-term storage of data through server computers and regular backup of data to ensure long-term effective storage of data.



4. Comprehensive data analysis functions:

This software can provide a perfect platform for analysis, judgment and decision-making to managers at different levels (technical level, management level and decision-making level) through data integration, storage and display in the actual production and R&D process.

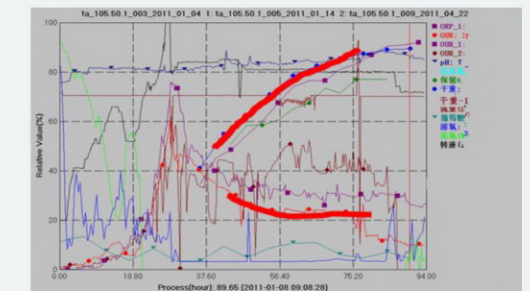

DATA SCIENCE

Bailun Huishen multi-scale analysis software (2)

Intelligent process analysis software

Independently developed an intelligent process analysis software IKnow, for the production line of the fermentation workshop, which is used for data and knowledge management of the production process of the fermentation workshop, and realizes efficient optimization and amplification of the fermentation process.

Main functions:

- Multi-tank real-time data collection with one click
- Quick docking of various types of parameters
- Multi-scale correlation analysis of parameters
- Quick identification of batch number differences
- Automatic perception of metabolic status
- Intelligent prompts for process operations

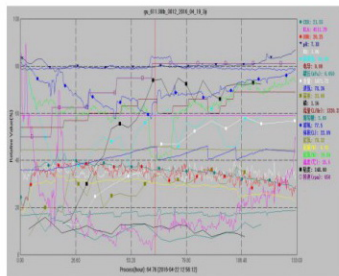

Multi-tank real-time data collection by group with one key

In one IKnow software interface, the data management of multiple fermentation tank batch numbers can be realized, and the batch numbers of multiple tanks can be established and real-time data can be collected only by the one button.



Quick docking of various types of parameters

IKnow software can manage data such as real-time acquisition, manual measurement, intracellular metabolism, cell morphology and event recording, and can comprehensively use these data to calculate OUR, CER, RQ, K_{la} , cell specific production rate, substrate specific consumption rate and product ratio. The parameters that characterize the metabolic state, such as the production rate, significantly improve the effectiveness and reliability of process optimization and scale-up.

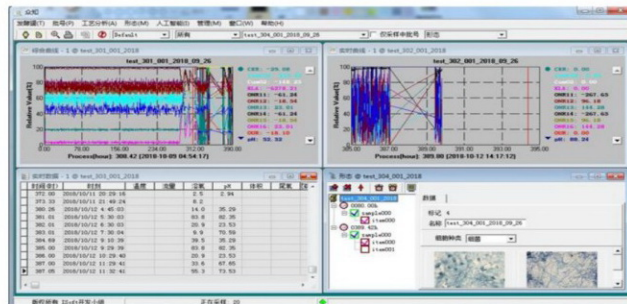

Parametric Multiscale Correlation Analysis

Using various parameters of the IKnow software, it is convenient and efficient to conduct multi-scale correlation analysis, and quickly find effective strategies for process optimization and scale-up.

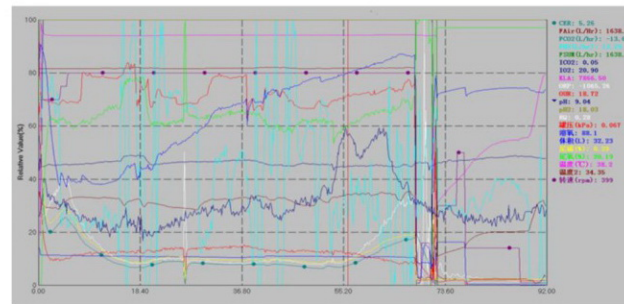

Quick identification of batch number differences

It is a very useful function in the analysis of the fermentation process to compare the data differences of the same fermenter or different batches of different fermenters on the same screen. Through this comparison, the change of process parameters under different experimental conditions (such as different scales or different operating conditions) can be observed intuitively. IKnow software can compare any number of batches of data on the same screen through the integrated curve view.

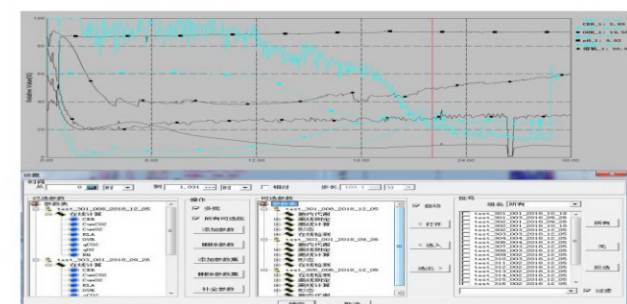

Automatic perception of metabolic status and intelligent reminder of process operation (only the smart version has this function)

From the perspective of artificial intelligence and big data analysis, the focus of this version of the software is to break through the problem of data islands in biological processes and further solve the problems of data storage, data display and analysis. In the next step, the software will be continuously upgraded and transformed to further realize online fact analysis of data, integrate a powerful biological knowledge base, automatically realize the diagnostic function of process data, and integrate biological system biology (genes, metabolic flow) information to provide powerful biological production and R&D solutions for production and R&D intelligent software.

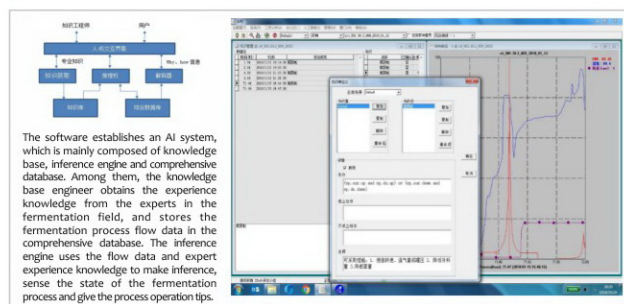

CONTROL SYSTEM MODULE

System Software

BLBIO-v3.1 biological fermentation control software interface

Independent design and independent intellectual property rights provide accurate theoretical basis for fermentation research

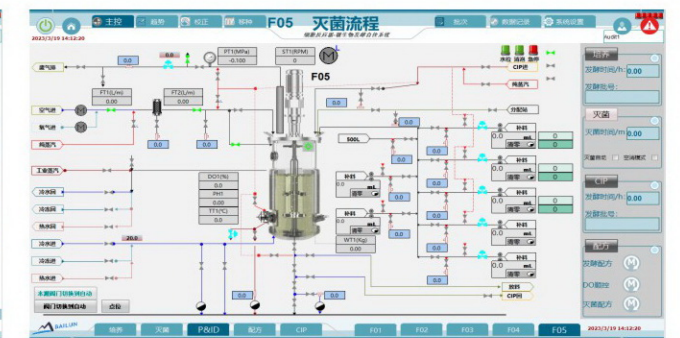
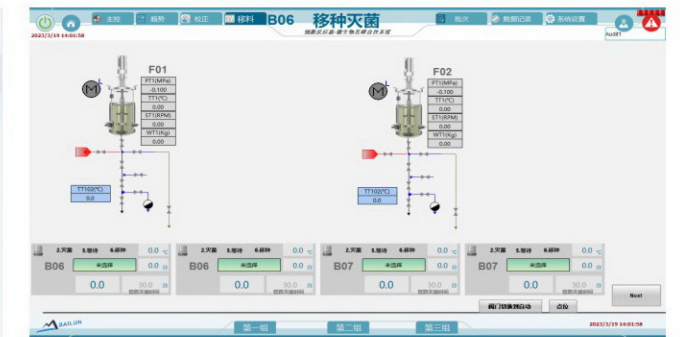

MAMMALIAN CELL BIOREACTOR

Mammalian cell bioreactor (glass vessel - top magnetic mixing, rack and the tank can separated quickly, safe, simple and convenient)

The cell bioreactor adopts the latest mechanical processing and manufacturing technology to meet the needs of users for culturing adherent cells and suspension cells, and meets the requirements of cGMP and FDA. The working volume has five specifications: 2L, 3L, 5L, 7.5L, and 15L. It can be used for batch culture and continuous culture of animal cells, insect cells, and plant cells, suitable for the culture of suspension cells, microcarriers and sheet carriers.



3L double cell bioreactor

10L cell bioreactor

10L cell bioreactor



150L mammalian cell bioreactor

Mammalian cell bioreactor (stainless steel vessel - top magnetic driving, safe and efficient, simple and exquisite)

Modular in design and available in configurations ranging from basic to full-featured, the system offers a complete solution for every budget and need. At the same time, it uses advanced pressure vessel manufacturing technology and integrates many necessary and advanced functions, which can almost meet the various needs of modern biopharmaceutical applications. The culture volume can be from 20L to 5000L, and it has been successfully used in BHK/BSR, VERO, CHO, MDCK293, MARK145 and other cell cultures.

Applications:

Mammalian cells, insect cells, suspension cell culture, microcarrier adherent cell culture, sheet carrier adherent cell culture, vaccine, virus preparation, recombinant protein and antibody process development and medium optimization

Including:

CHO and hybridoma cell culture express monoclonal antibody Vero/MDCK/diploid/primary cell sheet carrier/microcarrier culture of various viruses, HEK293 cell culture adenovirus, insect cell baculovirus system, and CHO/293 transient High-throughput expression of recombinant proteins, cell therapy, etc.



50L-250L Secondary Mammalian Cell Bioreactor



1000L Secondary Mammalian Cell Bioreactor

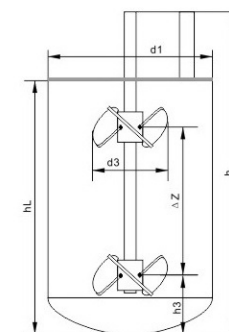

Specification	35L	50L	100L	150L	200L	300L	500L	1000L	2000L	3000L	5000L
Total volume (L)	47L	67L	133L	200L	267L	400L	680L	1300L	2700L	4020L	6604L
Maximum working volume (L)	35L	50L	100L	150L	200L	300L	500L	1000L	2000L	3000L	5000L
Fermenter diameter d1 (mm)	300	367	500	550	600	700	850	1000	1300	1500	1700
Fermenter height h (mm)	470	580	700	750	900	900	1070	1500	1800	2000	2600
h/d 1	1.56	1.58	1.4	1.36	1.5	1.29	1.26	1.5	1.4	1.3	1.5
Filling height hL (mm) Liquid content	352.5	435	525	523	675	675	803	1125	1350	1500	1950
d2.3- Blade (mm)	150	130	250	275	300	350	425	500	650	750	850
d2.6- Blade (mm)	/	/	/	/	/	/	/	/	/	/	/
h3(mm)	120	130	200	220	240	280	340	400	520	600	680
$\Delta z=1.3 \times d2$, 3-blade segment impeller	195	104	325	357.5	390	455	552.5	650	845	975	1150

AIRLIFT BIOREACTOR SYSTEM

Air-lift stirring fermentation system - suitable for microbial cultivation that requires little shear force

The built-in guide tube forces the medium to convert up and down, and the special air distributor



BLBIO-5GQ 5L
Sterilization-in-situ airlift glass fermentation system



BLBIO-100SQA 100L
Air lift mixing stainless steel fermentation system

SOLID-STATE BIOREACTOR SYSTEM

Solid-state fermenter

The solid fermentation system used in the pharmaceutical, beverage, enzyme preparation, biopesticide and other industries has the advantages of low investment, good sterility, low operating environment, simple maintenance and not easy to pollute the environment, etc. Solid fermentation equipment with volumes ranging from 5L to 50KL.



BLBIO-10SS 10L
Solid Fermentation System

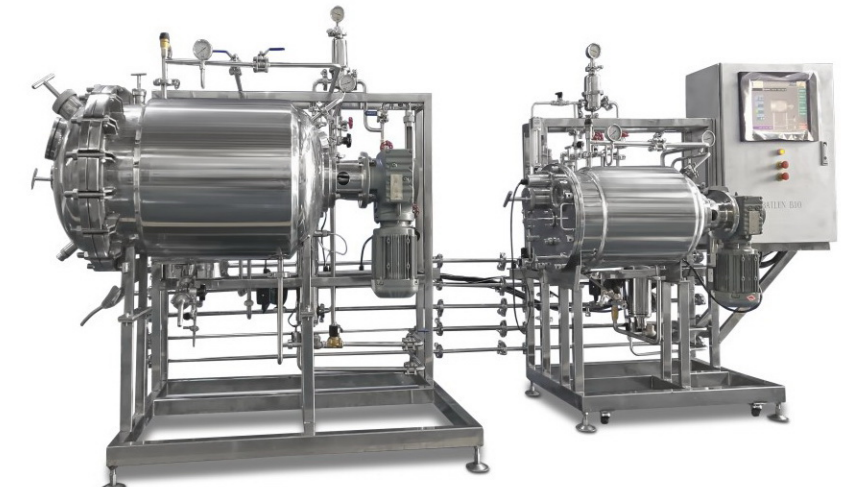

BLBIO-50SS-150SS 50L-150L
Solid Secondary Fermentation System

PLANT CELL BIOREACTOR (LIGHT)

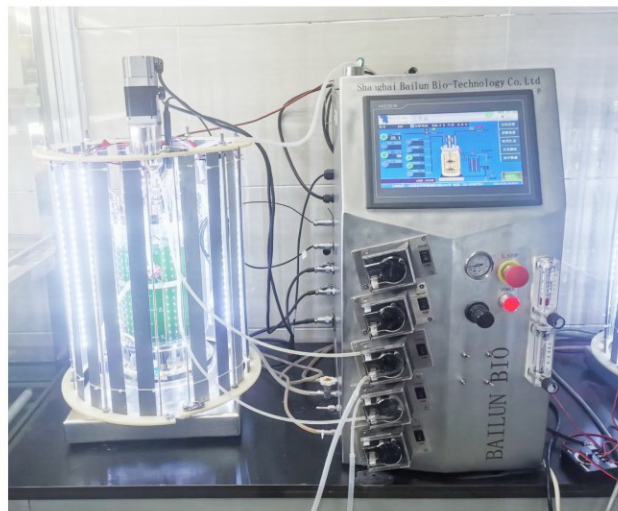

BLBIO-5GCL 5L
Magnetic mixing photobioreactor (off-site sterilization)



BLBIO-1000S JL-1000S JL 1000L
Double stainless steel photobioreactor



BLBIO-20000SS 20L
Solid Fermentation System



BLBIO-50000SS 50L
Solid Fermentation System

CENTRIFUGE

The main products of the centrifuge are:

high-speed tube centrifuge series, disc centrifuge series and other products. Reliable quality and excellent performance, the products are widely used in pharmaceutical, biological products, blood products, chemical industry, food and beverage and other industries. Users are welcome to conduct various technical consultations. For the equipment purchased by users, the company is responsible for installation and commissioning, on-site guidance and training, until it is put into production.



Main Technical Parameters

Model	Separation factor (xg)	Drum inner diameter (mm)	Drum length (mm)	Drum volume (L)	Rotating speed (r/min)	Water flow (m3/h)	Motor Power (Kw)	Weight (Kg)
JM-2	17000	76	430	2	20000	0.2	1.5	180
JM-6	15000	105	730	6	16000	1.2	3	550
JM-6T	15000	105	730	6	16000	1.2	3	550
JM-6F	15000	105	730	6	16000	1.2	3	550
JM-11	15900	142	820	10	14000	1.5	3	550
JM-11FC	20000	142	820	11	16000	2	3	900

HIGH PRESSURE HOMOGENIZER

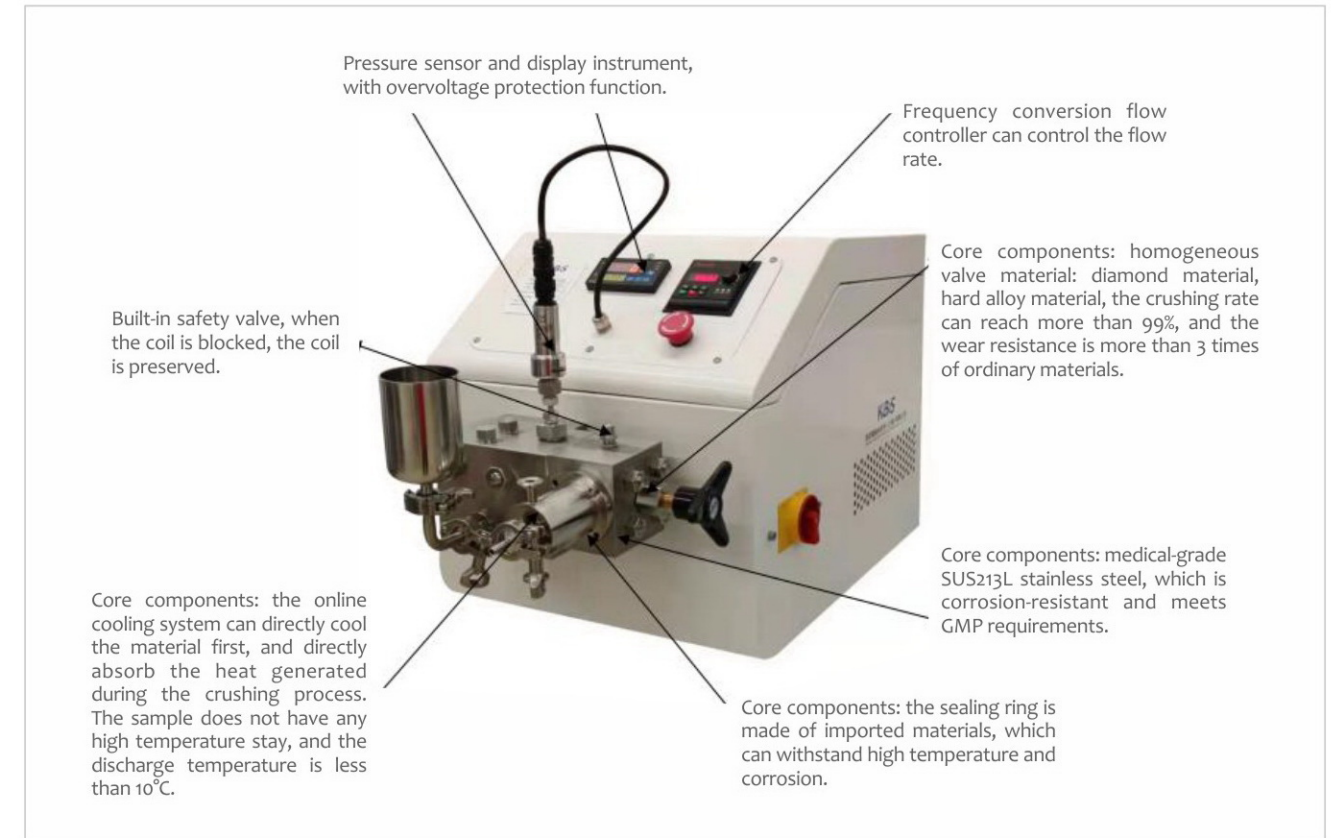

Laboratory, Pilot And Production Equipment Models:

Device model	Motor Power	Device power	Processing capacity	Work pressure	Minimum throughput
BL-2000	1.5Kw	220V/50Hz	3-15L/H	2000bar	16ml
BL-1500L	1.5Kw	220V/50Hz	10L/H	1500bar	25ml
BL-1000	1.5Kw	220V/50Hz	15-30L/H	700bar	50ml
BL-11	11.0Kw	380V/50Hz	100-150L/H	1500bar	1000ml
BL-22	18.5Kw	380V/50Hz	500-600L/H	1000bar	3000ml
BL-37	37Kw	380V/50Hz	700-800L/H	1500bar	5000ml