

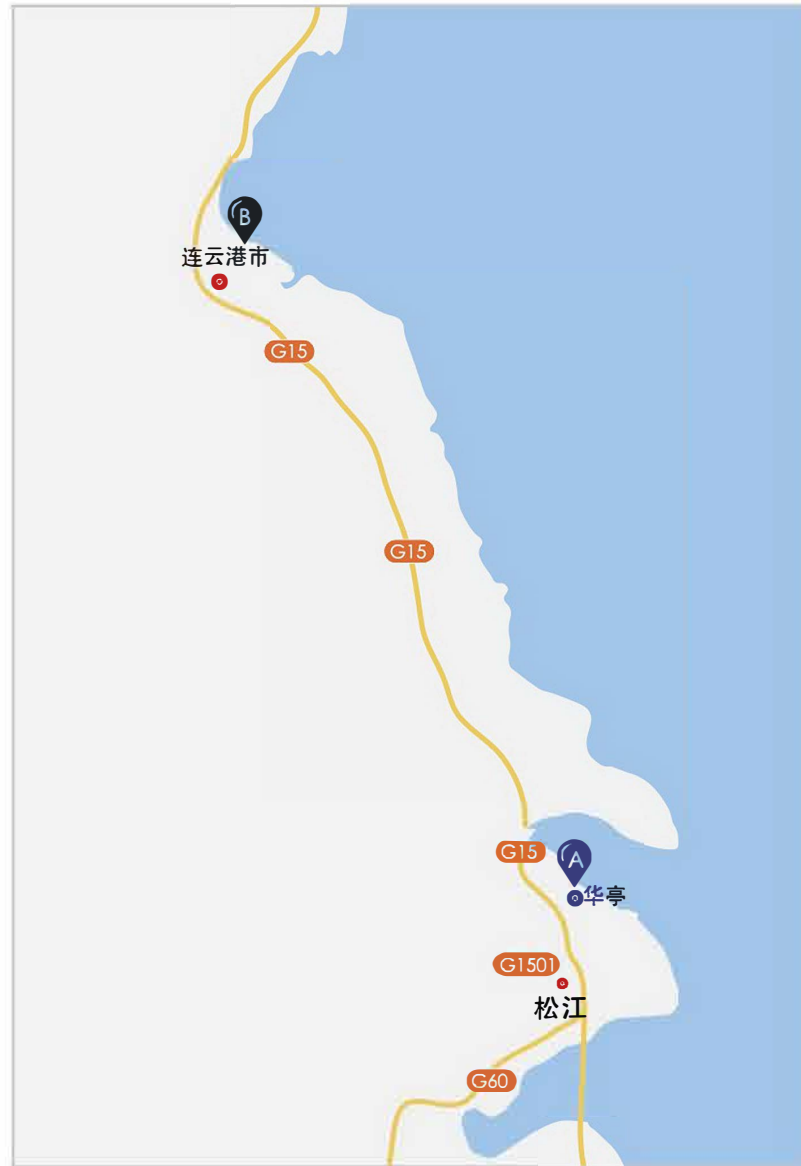

Join my WeChat

All rivers flow into the sea, Mount Kunlun is top in the sky
Great virtue can carry all things, Truth-seeking and innovative



BAILUN SHANGHAI FACTORY

Address: Building 3, No.28 Huojiao Road, Songjiang, Shanghai
Tel : 021-67867376 +86-13968006641
E-Mail: info@bailunbio.cn
Web: www.bailunbioreactor.com / bailunbio.cn

BAILUN BIOTECH (JIANGSU) CO.,LTD

Address:No. 3 Liangong Road, Liangong Automatic Control Equipment
Industrial Zone, Dunshong Town, Gonyu District, Lianyungang
Tel : 0518-85215152 +86-13968006641
E-mail: info@bailunbio.cn
Web: www.bailunbioreactor.com / bailunbio.cn



BIOLOGICAL SPECIALTY DRUGS GMP

www.bailunbioreactor.com
www.bailunbio.cn

BAILUN

www.bailunbioreactor.com
www.bailunbio.cn

- **2008** Shanghai Bailun Biological Technology Co., Ltd.
- **2009** Lianyungang Bailun Biochemical Technology Co., Ltd.
- **2017** Lianyungang Bailun Bioreactor Technology Co., Ltd.
- **2021** Bailun Biotechnology (Jiangsu) Co., Ltd.
- Current Bailun has more than 20,000 sets of equipment in more than 90 countries and regions around the world stable operation, continue to create value for users!

Introduction:

In order to better serve the biomedical industry, Bailun is committed to the research and development and manufacturing of biomedical equipment. The engineering problems of cells and bacteria in the process of large-scale culture have the following characteristics:

Metabolic problem: The proportion of various nutrients consumed by different pathways is essentially the result of the migration of cellular metabolic states, requiring a variety of metabolic data (macro and micro) during the culture process should be detected in real time and comprehensively.

Reactor flow field problem: In the complex non-uniform flow field environment, the metabolic characteristics will have specific changes, resulting in amplification effect, requiring a comprehensive analysis of the flow field state of the reactor.

Reactor manufacturing problems: It involves a variety of cell lines, culture forms and culture processes, and the technology is difficult and the standard management is strict. It is required that the animal cell reactor can achieve large scale, automation and refinement.

After years of practice, a complete set of technical methods and solutions have been formed: PAT technology, Metabolic flows analysis technology, CFD technology, reactor manufacturing technology and GEP management. Thereby provide a reliable basis for the reactor design, always implement the concept of "quality comes from design and quality risk management", from DOE to control systems to analysis software to intelligent optimization software, it seamlessly integrates with existing systems from upstream to downstream.

Among them, the application research of PAT in the cultivation process – process optimization and control based on PAT is an important content, which mainly includes:

Cell physiological and metabolic state determination: The equilibrium of the cell physiological state, is the key to cell growth and product expression. The online detection of culture process provides theoretical basis for the metabolism regulation of culture process.

Determination of key process parameters: The key sensitive parameters of cell physiological characteristics were determined by associating the physiological state of cell metabolism with cell growth dynamics, viral reproduction dynamics and antibody quality. Real-time detection of cell growth state, virus reproduction state, antibody expression and quality changes state; To provide the basis for the accurate selection of process control nodes (loading or infusion time, inoculation time, etc.).

Product harvest time determination: Cell activity and apoptosis; To provide the basis for the accurate judgment of the end point of the production process; Minimize cell DNA release.

Among them, the development of bioreactor equipment production system in line with CGMP standards mainly includes the following contents:

Controller system development: including process control system, data acquisition system, process analysis system.

Integrated system development: Based on the life-cycle model, carrying out design, manufacturing and installation, GMP verification (RA, DQ, IQ, OQ, FAT and SAT, etc.), operation and maintenance.

ERP management system and ISO9001 Thus forming warehouse material management, production planning instruction, production and manufacturing, finished product inspection warehousing, product delivery, quality traceability.

Thus it forms process traceability, GMP design and PAT implementation.



COMPANY PROFILE

Bailun Biotechnology (Jiangsu) Co., Ltd. is a leading supplier of intelligent data-driven bioreactor systems in China. Products cover all kinds of bioreactors in laboratory, pilot scale and industrial production, including fermenter, animal cell bioreactor, plant cell bioreactor, single-use bioreactor, liquid dispensing system and disposable reactor, etc. Can produce bioreactor of 0.1L-1000KL volume and technical services, and provide intelligent and personalized comprehensive solutions for bioreactors process. Bailun has a large number of experienced fermentation process, biochemical equipment and chemical technical engineers, many famous experts and scholars as the company's technical consultants, Bailun forever pursuit to create value for customers, adhere to customer-centric is the core value of Bailun.

In order to optimize and enlarge the production of process products in biological processes, various problems in the process need to be studied, therefore, a variety of research instruments and equipment are designed, and various conclusions are obtained through experiments and used in production practice. This equipment for the study of biological processes can be divided into seed material studies of living cells with the main objective of synthetic biology, and problems arising from changes in the transfer characteristics of process mixing, for which various bioreactor devices have been formed. To this end, the company to the above content as the goal, combined with the actual situation of users organized a series of devices for research products. Among them, there are products for high performance cell line acquisition device, biological reactor products for obtaining bacterial physiological characteristics, experimental equipment for biological process optimization and amplification, bioreactor system for intelligent biological process, as well as a variety of measurement, sterilization or sampling manual operation, data processing software packages, GMP operating characteristics and other components research products for users to choose.

Bailun Spirit:

Customer foremost, seeking quality, fairness and honesty, continuous improvement!

BAILUN QUALIFICATION

Honor exists because of customers: because all our efforts are for the satisfaction of customers. Honor is the affirmation, trust and spur, honor is our golden card and pass, honor is our signpost and a journey, Honor represents the past. Bailun people regard honor as an inexhaustible motivation to encourage their own continuous improvement and progress.

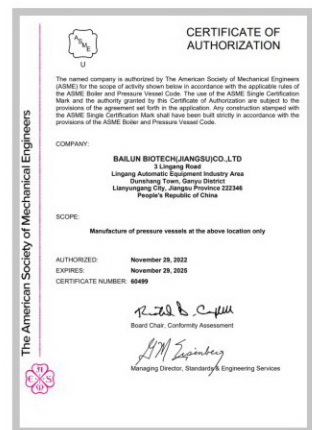
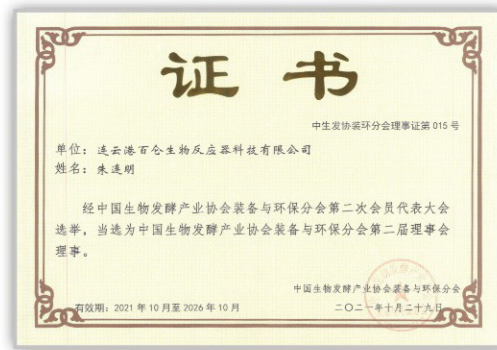

First-class quality, from the innovation of technology!

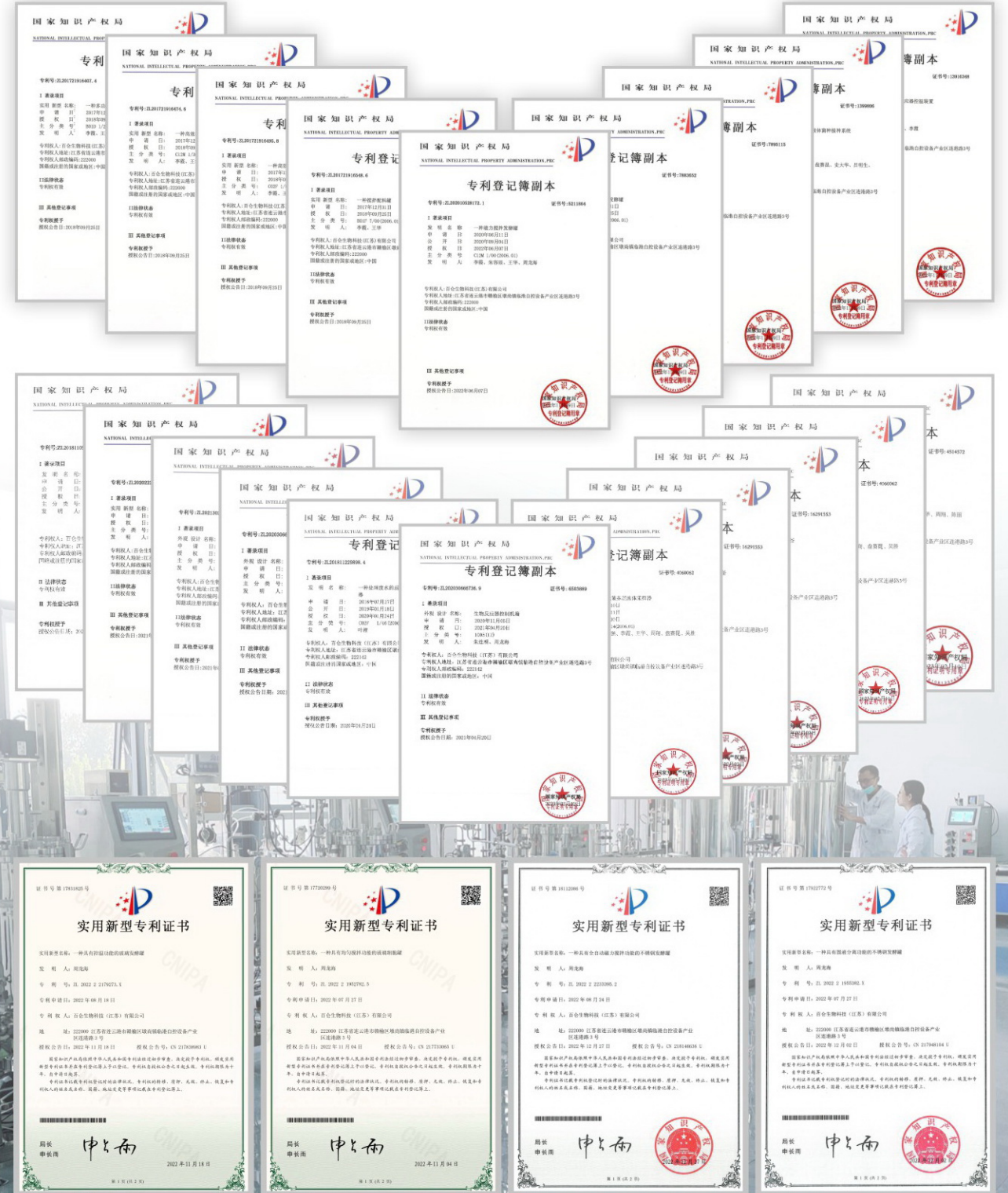

SALES, PRODUCTION AND VERIFICATION PROCESS

A professional verification team with rich verification experience can complete the whole process of verification services from initial communication, plan drafting, writing, formulation and implementation to report completion. It covers HVAC system, process system, automatic control system, water system, clean compressed air system and the verification of equipment and facilities.

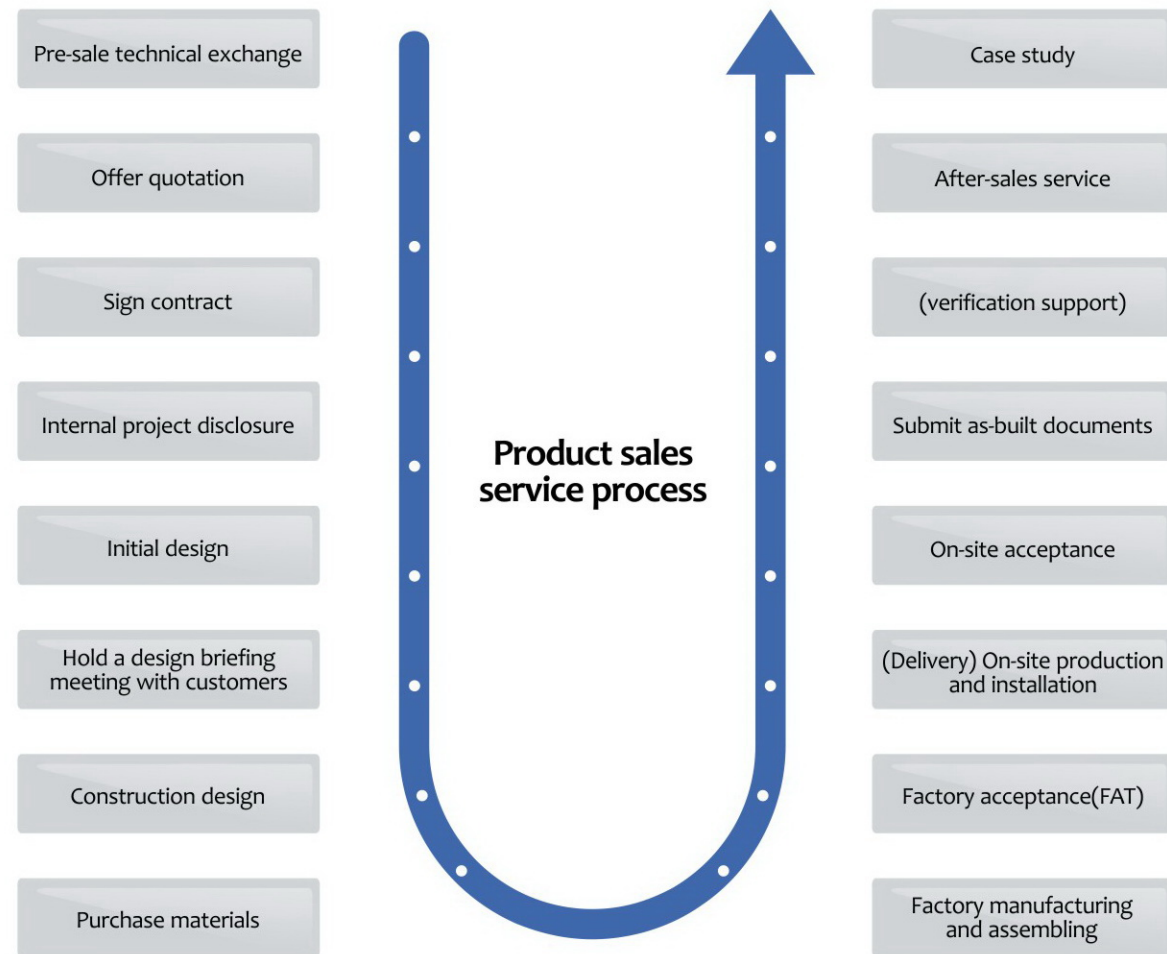

VERIFICATION SUPPORT

The verification process strictly follows GMP, GDP, GAMP5 and other standards, and provides customers with DQ, IQ, PQ and OQ program preparation, implementation and related services. Ensure traceability of all documents.

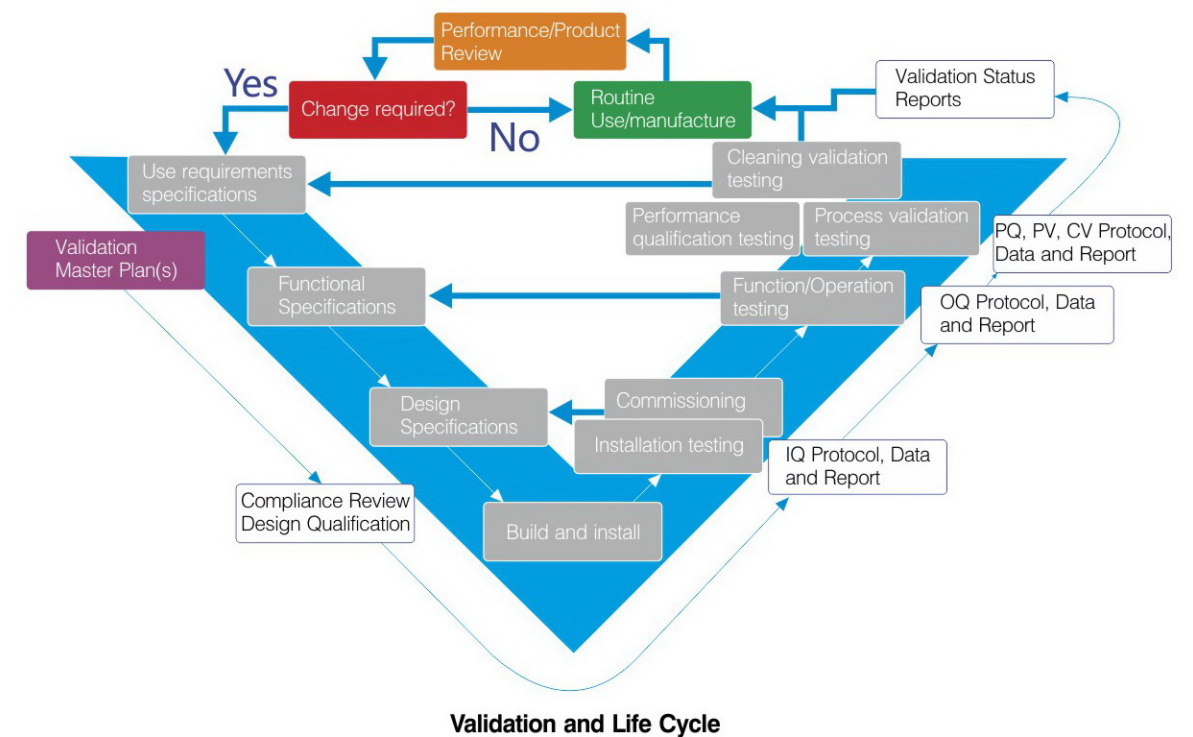
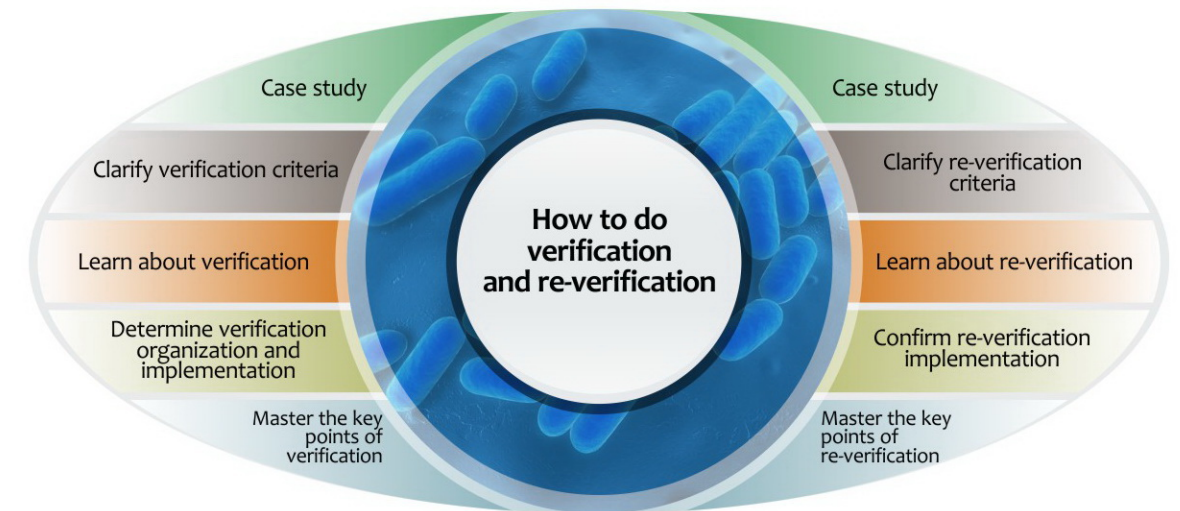

Validation and Life Cycle

SYSTEM SOFTWARE

BLBIO-v3.1 Biological fermentation control software interface

Independent design, independent intellectual property rights, provide accurate data and analysis for your research and production.

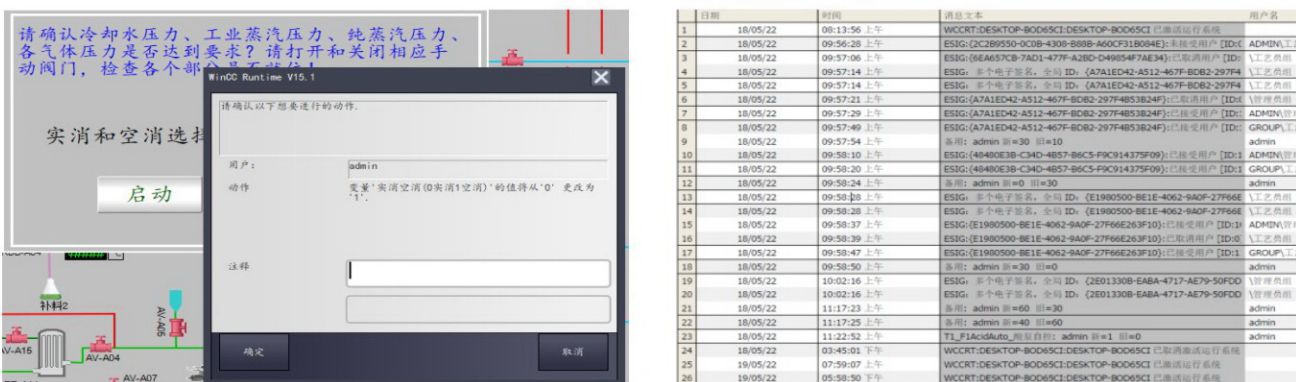
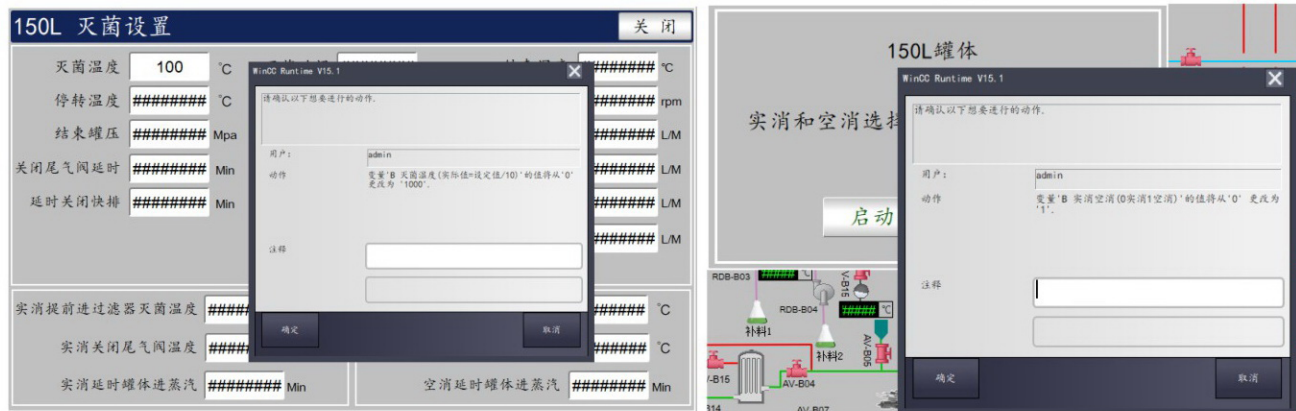
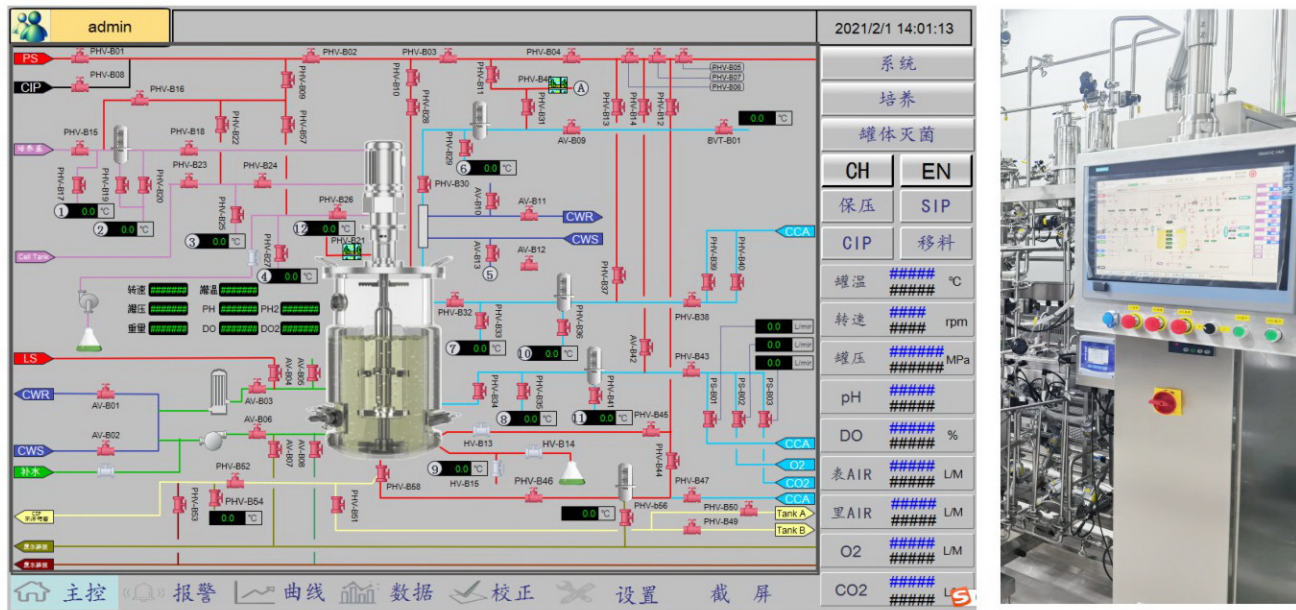

TRACKING MANAGEMENT

After years of practice, a complete set of technical methods and solutions has been formed: PAT technology, metabolic flow analysis technology, CFD technology, reactor manufacturing technology and GEP management. So as to provide a reliable basis for reactor design, and always implement "quality originates from design and quality risk management", from DOE to control system to analysis software and finally to intelligent optimization software, seamlessly integrate with existing systems from upstream to downstream.

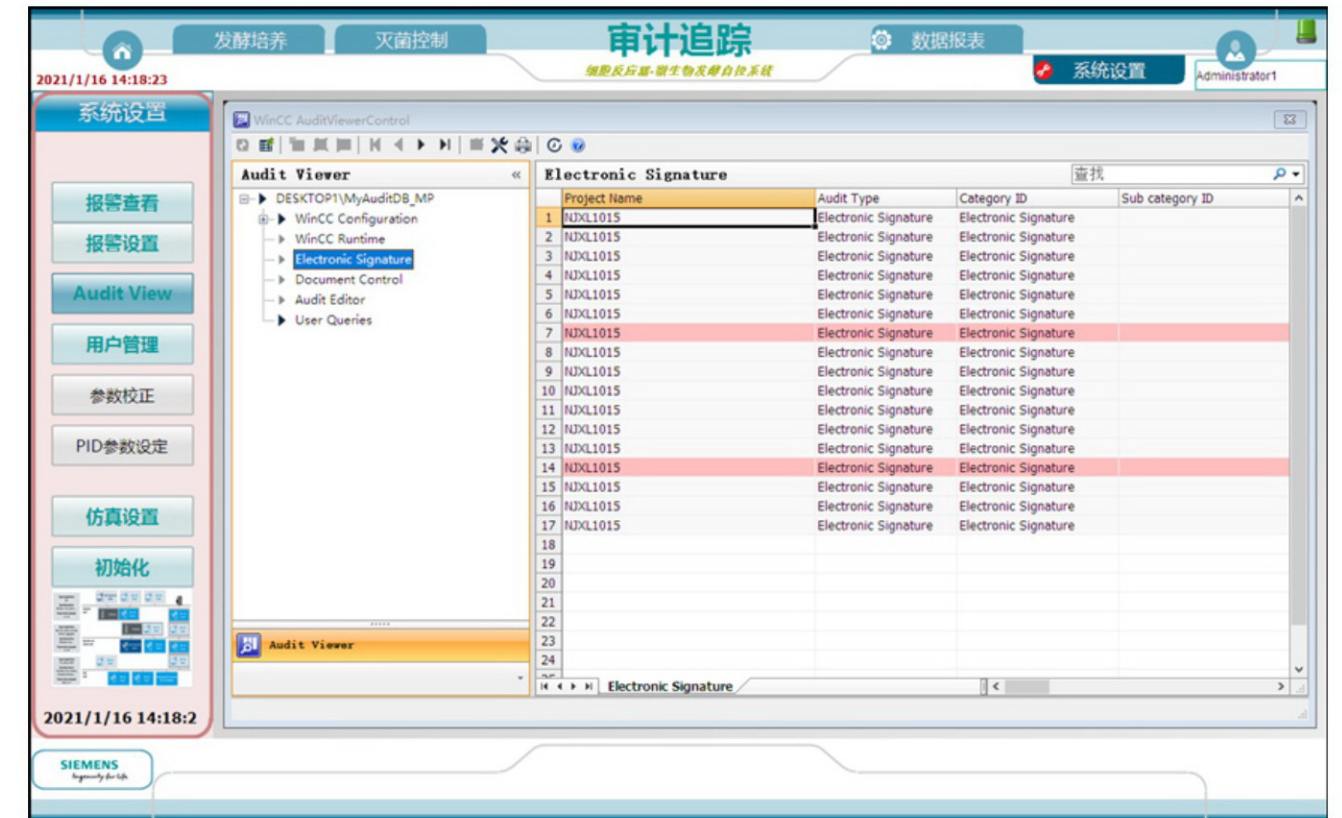

ELECTRONIC SIGNATURE

Based on the electronic management system of PKI electronic signature technology, we formulate the electronic signature work specification based on the digital signature certification authority (CA).

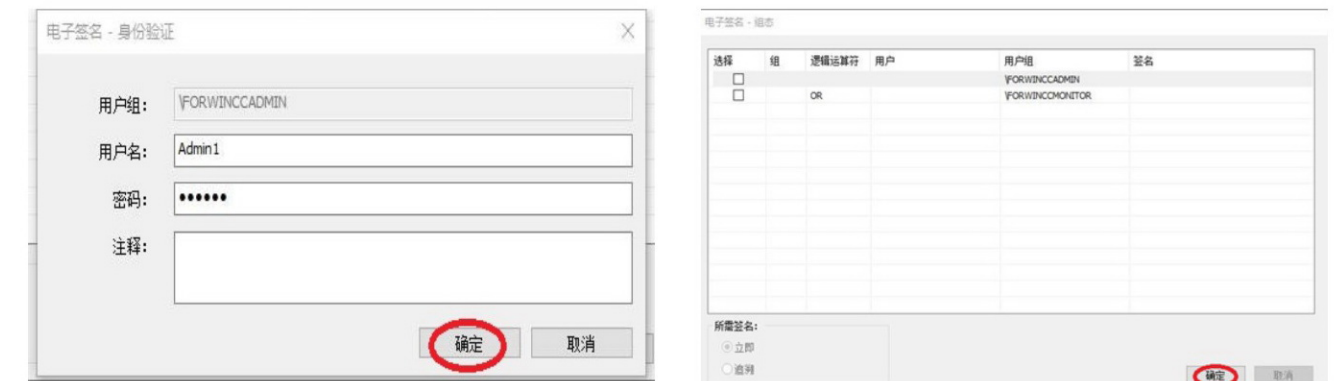

3D DESIGN

Three-dimensional design, combined with the actual situation on site, provides the most optimized design scheme. Bailun uses design software such as CADworx and AUTO CAD to carry out professional design for customers, and provides overall modular process engineering and technical services, so that customers can meet the relevant cGMP requirements of SFDA, FDA, WHO and the European Union.

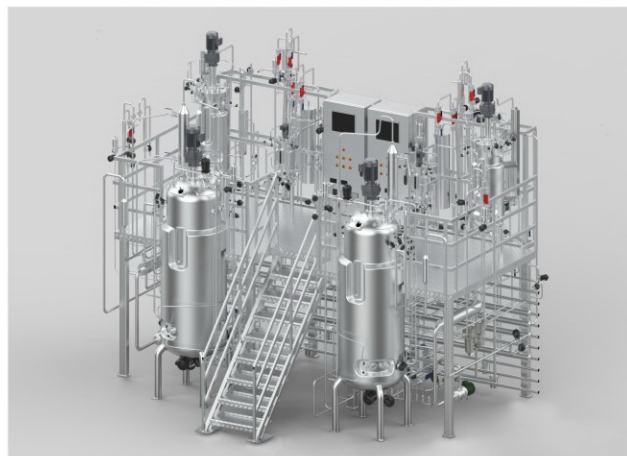
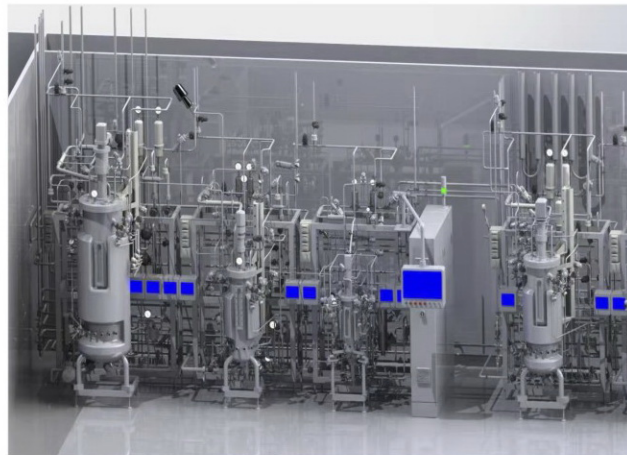
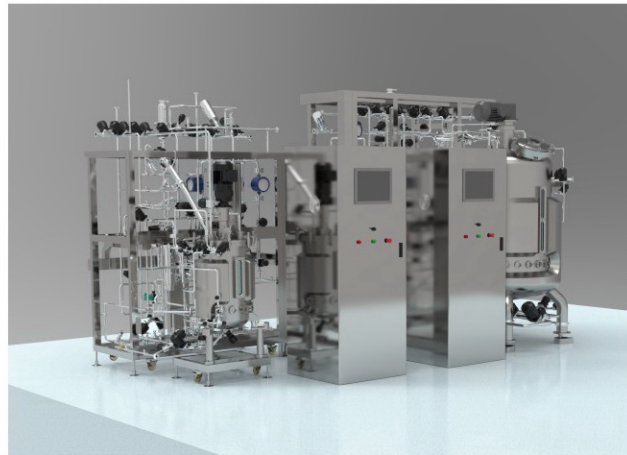

CGMP COMPLIANT BIOREACTOR DESIGN AND MANUFACTURE

Bailun has a number of professional and technical personnel in the fields of fermentation engineering, biochemical engineering, automation control, computer, mechanical engineering, etc., all of whom have a lot of experience in fermentation engineering design and on-site construction. To help users with various problems in production and process, provide a complete set of process solutions, and make due contributions to improving the industrialization capacity of my country's biotechnology field with high-quality product quality and high value-added services.



Clean room pipeline through the wall system



Clean room sewage treatment



Conversion plate



Electrolytic polishing



Automatic feeding control system



Full intelligent electric and gas circuit control system



Intelligent pressure regulating valve system



Double exhaust filter system



Intelligent thermal mass flow meter system



Weighing module



Quick open irrigation system



Traps



Exhaust system



Isolator



Upper magnetic stirrer



Automatic sampling

DESIGN AND MANUFACTURE OF MIXING SYSTEM IN COMPLIANCE WITH GMP

Double mechanical sealing agitation system

Upper mechanical stirrer

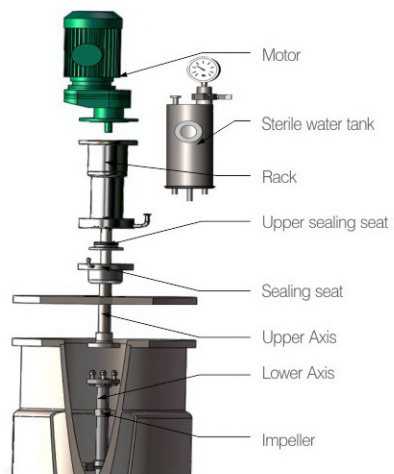

Bottom mechanical stirrer

Room height is saved, the center of gravity of the equipment is lowered, double-end mechanical seals are steam sterilized, steam condensate is cooled and lubricated, and biological safety is ensured. Continuous improvement and progress.

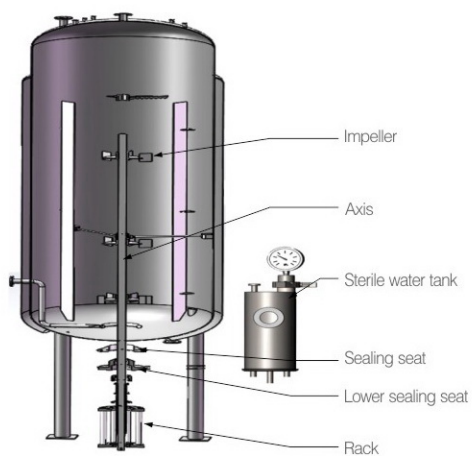

Magnetic stirring without mechanical seal system

Magnetic stirring is the best choice for high biological safety requirements and cell culture (up to 5000L)

It is suitable for the cultivation of plant, animal cells and microorganisms with a long cultivation period

Upper magnetic stirring

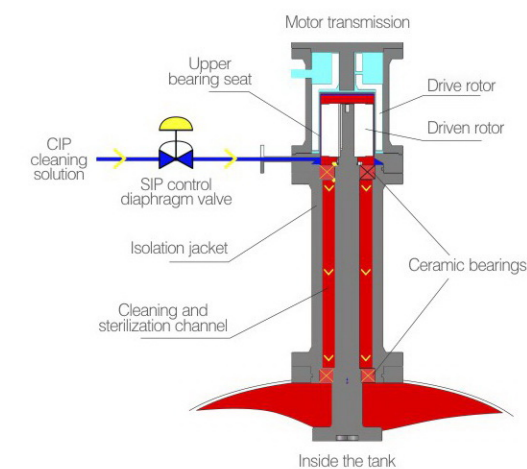

Bottom magnetic stirring (upper suspension)

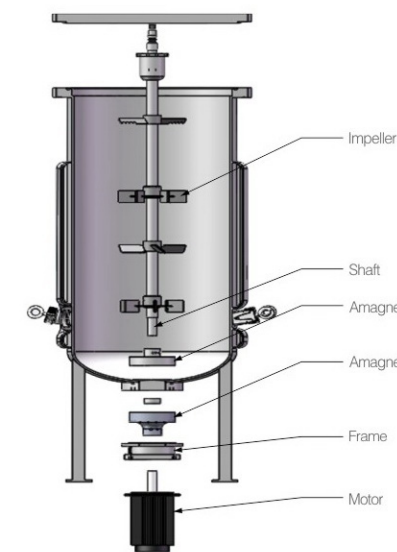

PROTEIN AND PLASMID PRODUCTION PROCESS

The professional design team perfectly applies the concept of QBD to product design, provides perfect design solutions, solves problems for customers, and makes it easier for customers to scale up from lab scale to pilot scale and even to industrial scale.



PROBIOTIC PROCESS

Reasonable layout, combined with the application of the platform on the basis of the open pipe frame design, facilitates the maintenance of the equipment and improves the space utilization rate, saving a lot of space for customers.



AUXIN ANTAGONIST PROCESS

The surface of the tank adopts a new treatment process, which not only improves the appearance of the tank, but also ensures the operability of cleaning. It also solves the problem of reflection on the surface of the tank and improves the user experience of the product. The height-to-diameter ratio of 3:1 and bottom mechanical stirring is beneficial to DO control.



VETERINARY VACCINE PRODUCTION PROCESS

Provide animal vaccine industry users with process and equipment production lines for foot-and-mouth disease, brucellosis, swine rings, swine parvo, swine fever, pseudorabies, avian influenza, and recombinant influenza. The simple and reasonable design greatly saves the cost on the premise of meeting the needs of customers, and truly achieves "cost reduction and efficiency increase".



HUMAN VACCINE PRODUCTION PROCESS - PERTUSSIS

Pertussis Culture System

- The height-to-diameter ratio of the reactor is 1.2~2:1, which is suitable for the cultivation of pertussis bacilli.
- Surface ventilation, deep ventilation integrated design, AIR, O₂ automatic flow ratio adjustment.



HUMAN VACCINE PRODUCTION PROCESS - TETANUS

The perfect sealing design, automatic CIP and SIP provide a safe guarantee for the production of highly pathogenic toxins; the unique exhaust gas treatment device effectively removes harmful gases and protects the environment while ensuring biological safety.

Tetanus Culture System

- The height-to-diameter ratio of the reactor is 2:1, which is suitable for the cultivation of clostridium tetani.
- Surface ventilation design, AIR automatic flow adjustment.



HUMAN VACCINE PRODUCTION PROCESS - DIPHTHERIA

Diphtheria Culture System

- The height-to-diameter ratio of the reactor is 1.2-1.8:1, which is suitable for the cultivation of diphtheria bacilli.
- Surface ventilation design, AIR automatic flow adjustment.



HUMAN VACCINE PRODUCTION PROCESS - HPV

The process system adopts pharmaceutical grade aseptic design, which can be cleaned or sterilized online. The tank body and material contact parts of the system are made of AISI 316L stainless steel, and the inner surface polishing grade reaches 0.2 μ m, the system is equipped with sensors for temperature, pressure, flow, PH, DO, OD and live cell detection, etc. The system complies with GMP and EU requirements, highly automated production, and advanced process system.



HUMAN VACCINE PRODUCTION PROCESS - PNEUMONIA

Pneumonia Culture System

- The height-to-diameter ratio of the reactor is 2~2.5:1, which is suitable for the cultivation of *Streptococcus pneumoniae*;
- Integrated design of surface ventilation and deep ventilation, automatic ratio adjustment of AIR and CO₂, CO₂ replaces O₂ in the culture medium;



HUMAN VACCINE PRODUCTION PROCESS - MENINGOCOCCAL MENINGITIS(ECM)

The design of the neisseria meningitidis vaccine bioreactor will greatly affect its performance. Therefore, when selecting the system, the microbial characteristics should be fully considered, and the product that meets the specific process requirements should be selected. For the design of classic products, we combine new technology on the basis of retaining classic design. Our innovative design can better meet customer needs and escort customers' continuous technological progress.

Epidemic Cerebrospinal Meningitis(ecm) Culture System

- The height-to-diameter ratio of the reactor is 1.25-2:1, which is suitable for the cultivation of Neisseria meningitidis group A and group C.
- Integrated design of surface ventilation and deep ventilation, AIR automatic flow adjustment



HUMAN VACCINE PRODUCTION PROCESS - HIB

The fermentation system is suitable for aerobic culture conditions of Haemophilus influenzae type B, meets the requirements of mass transfer and mixing, and meets the corresponding biosafety level requirements. The excellent hygienic design ensures no pollution in the cultivation process, and the redundant exhaust filter system design solves the clogging problem of the corresponding exhaust filter; the toxic and non-toxic separation design ensures the safety of production; the temperature cascade control of pulling sheath, automatic sampling and double plate exchange ensures the accuracy of process parameters.



ESCHERICHIA COLI/ PICHIA PASTORIS CULTURE SYSTEM

Cultivation of expression with Escherichia coli/ Pichia pastoris as a tool; the height-to-diameter ratio of the reactor is 2.5-3:1, suitable for Escherichia coli/Pichia pastoris mass transfer and heat transfer; "Surface ventilation, deep ventilation integrated design, AIR, O₂ automatic flow ratio adjustment AIR ventilation ratio 2VVM, O₂ ventilation ratio 1VVM;" Four-valve group aseptic feeding, methanol and ammonia online sterilization and filtration feeding.



MAMMALIAN CELL BIOREACTOR PROCESS

This production system applied to batch fed-batch or continuous perfusion culture of mammalian and animal cells. Provide a full range of suspension and fixed bed animal cell bioreactors, including 1L/3L/5L/7L/14L/20L/30L/40L glass cell bioreactors; 5L/14L/40L fixed bed animal cell glass bioreactor; 2-unit/4-unit/8-unit/16-unit multi-unit animal cell bioreactor; Intelligent enzyme reaction workstation; 45L/75L/200L-5000L animal cell or dual-purpose bioreactor, etc.



Tank injection, culture, rotation, ground filter retention device

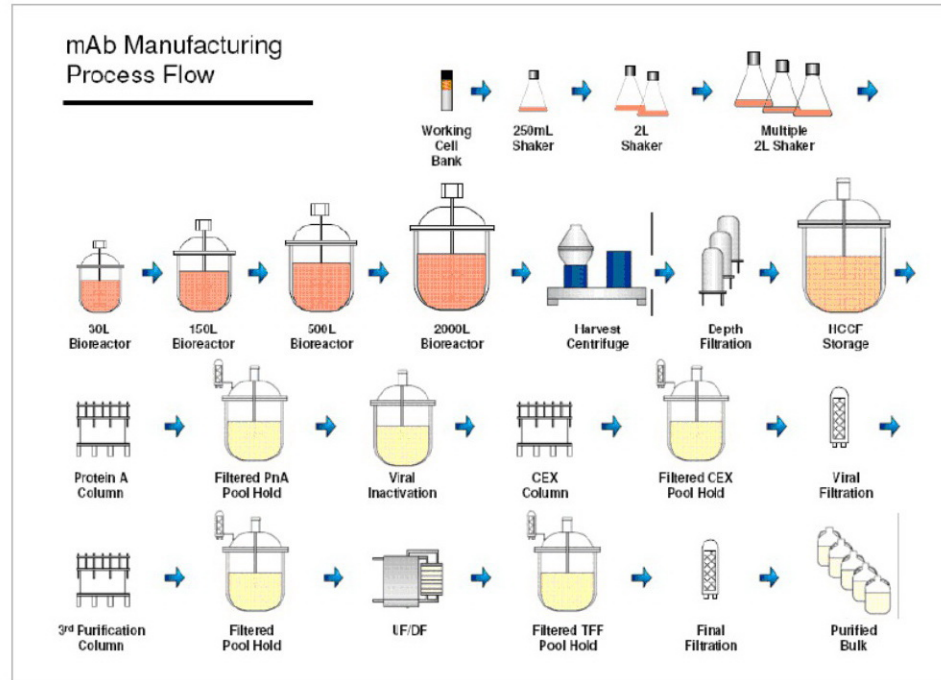

Stirrer For Suspension Cell Culture

The low shear rate stirring paddle is designed to ensure the safety of cell growth during the cell culture process. The stirring paddle designed by Bailun has been proven by users to have good stirring effect in cell culture.



MAMMALIAN CELL GLASS BIOREACTOR

Applied to batch fed-batch or continuous perfusion culture of mammalian and animal cells. The cell bioreactor adopts the latest mechanical processing and manufacturing technology to meet the needs of users for culturing adherent cells and suspension cells, and meets the requirements of cGMP and FDA. The working volume is 2L, 3L, 5L, 7.5L, 15L, 20L, 30L, 40L, which can be used for batch culture and continuous culture of animal cells, insect cells, and plant cells, equipped with propulsion stirring blade (Pitched Blade) and fixed bed stirring paddle, suitable for suspension cells, microcarriers and sheet carrier culture.

Applications:

Mammalian cells, insect cells; Suspension cell culture; Microcarrier adherent cell culture; Sheet carrier adherent cell culture; Vaccine, virus preparation, recombinant protein and antibody process development and medium optimization.

Include:

Cell cultures such as CHO and hybridoma express monoclonal antibody Vero/MDCK/Diploid/Primary cell sheet carrier/Microcarrier culture of various viruses, HEK293 cell culture adenovirus, Insect cell baculovirus system and CHO/293 transient high-throughput expression of recombinant proteins, cell therapy, etc.

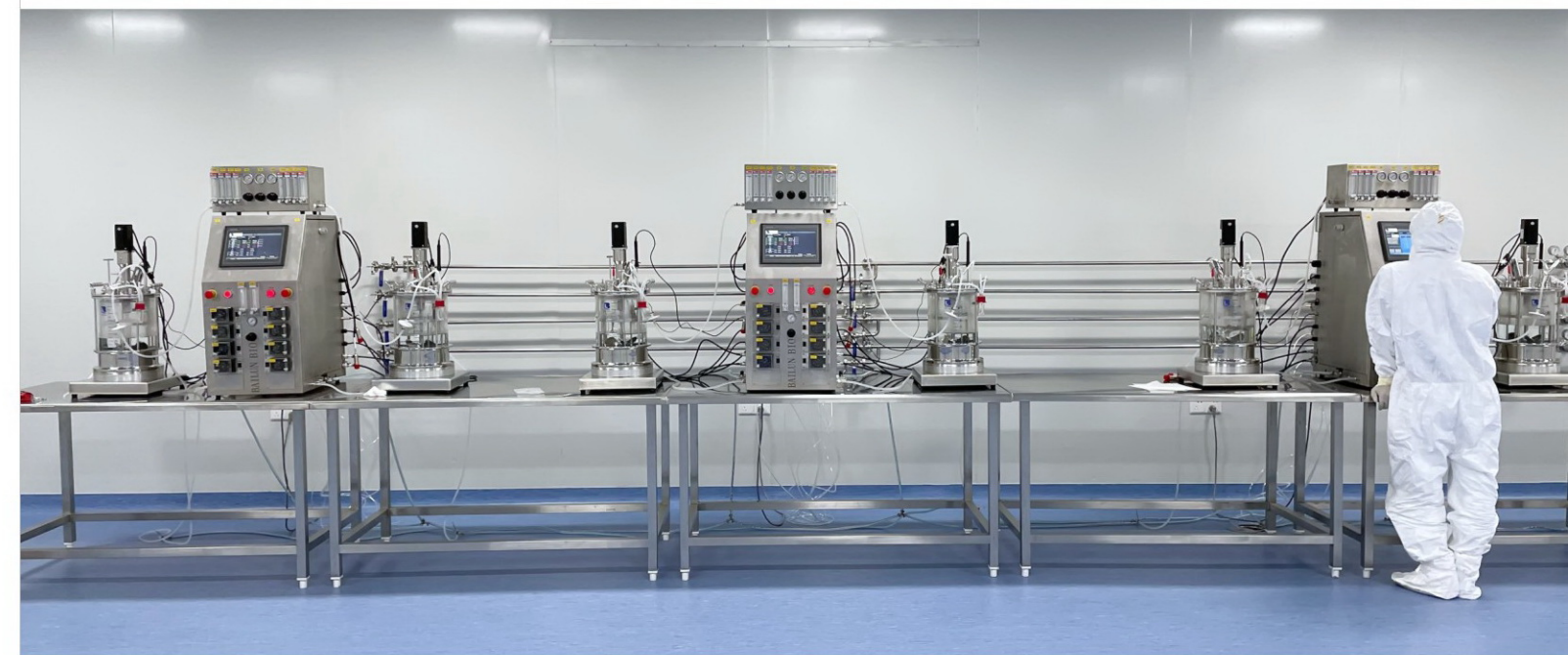

MAMMALIAN CELL STAINLESS STEEL BIOREACTOR

Modular in design and available in configurations from basic to full-featured, the system provides a complete solution for every budget and need. At the same time, it uses advanced pressure vessel manufacturing technology and integrates many necessary and advanced functions, which can almost meet the various needs of modern bio-pharmaceutical applications. The culture volume can be from 20L to 5000L, and it has been successfully used in BHK/BSR, VERO, CHO, MDCK293, MARK145 and other cell cultures.



HUMAN VACCINE PRODUCTION PROCESS - COVID 19

Since the outbreak of COVID-19, Bailun broke through many difficulties and devoted itself into the research, development and manufacture of bioreactors. As an overall solution provider for human vaccine bioreactors, Bailun has provided high-standard bioreactor equipment for many domestic and foreign bio-pharmaceutical companies. Provide key process module equipment including buffer preparation system, harvesting/inactivation system and CIP unit for the production workshop.

Meet different COVID-19 vaccine technology routes:

- Inactivated vaccine
- Genetically engineered subunit vaccines
- Adenoviral vector vaccine
- Attenuated influenza virus vector vaccine
- Nucleic acid vaccine



WAVE BIOREACTOR



The wave bioreactor mixes by rocking action, without adding any mechanical agitation in the disposable culture bag to achieve mixing; suitable for a variety of cell culture applications, including conventional batches, fed batches and perfusion culture processes

Features:

1. The wave bioreactor automatic feedback controller adopts advanced PID feedback control technology to monitor the cell culture process in an all-round way to achieve a more stable and reliable cell culture process.
2. The system is designed with a touch screen, using high-precision TMFC mass flow meters to achieve air, CO₂, O₂ mixing, with a new generation of high-precision optical fiber PH technology and DO optical fiber dissolved oxygen technology, and PLC control programs. Realize comprehensive monitoring and automatic control of key parameters such as PH, DO, air, CO₂ and O₂.
3. The control system is capable of data collection, real-time curve recording, historical record tracing, result comparison and report printing, which meets the requirements of regulations.
4. Provide a large specific surface area. Instead of cell factories and spinner bottles for cell seed preparation and virus seed preparation.
5. Provide a dynamic culture environment. Provides a better growth environment than cell reactors.
6. Digestible transfer amplification.
7. One-time sealed environment operation, less risk of pollution.
8. The harvested product can be freeze-thawed directly.
9. Configure a suitable microscope for direct observation.

SINGLE-USE STIRRED BIOREACTOR



Single-use bioreactors are bioreactors that use single-use bags instead of culture vessels made of stainless steel or glass. The device uses an agitator similar to a traditional bioreactor, but the agitator is integrated into the reaction bag. The closed bag and stirrer are pre-sterilized using gamma irradiation. When in use, the disposable bag is installed in the support of the fixed bioreactor, and then the stirrer is connected to the driver.

Name	50L	100L	250L	500L	1000L	2000L
Working volume	50L	100L	250L	500L	1000L	2000L
Minimum working volume	10L	20L	50L	100L	200L	400L
Bioreactor total volume (non-working volume)	65.5L	120L	316L	660L	1320L	2575L
Stirring blades (quantity*number of blades)	1 × 3	1 × 3	1 × 3	1 × 3	1 × 3	1 × 3
Stirring mixing rate range (rpm)	30-200	30-200	30-150	30-150	20-110	20-75

LIQUID DISPENSING PROCESS

The liquid dispensing system provides technological support for biological culture, separation and purification, and inactivation and emulsification of vaccines. Together they constitute a process chain that intersperses throughout the entire process of bio-pharmaceuticals.



CIP PROCESS

CIP station is a set of independent process modules, usually the working mode is passive mode; According to the customer's cleaning process, we can provide fixed or mobile single-tank, double-tank or multi-tank structure, and customers can choose to configure heating, adding acid, base cleaning agent cleaning and other functions; The CIP cleaning process adopts a fully automatic cleaning method, which is displayed graphically through the man-machine interface. Customers can flexibly adjust the formula to meet the needs of different production processes, and can automatically adjust various related process parameters such as cleaning time, pressure, flow, temperature, etc. It can carry out automatic preparation of different detergent concentrations and automatic detection of CIP cleaning effect. At the same time, all operations can be recorded, which is convenient for system certification.



DOWNSTREAM SUPPORTING PROCESS

Bailun provides complete bio-pharmaceutical upstream and downstream process system equipment and comprehensive solutions, which can meet the different process requirements of customers' cell culture or microbial fermentation, including medium preparation, seed expansion, cell culture and fermentation, harvest and clarification, buffer preparation and storage, chromatography system, ultrafiltration system, etc., to help customers achieve high-standard and efficient technological processes.



Exhaust gas deactivation treatment system tank



Four-tank inactivation system



Liquid dispensing and purification system



Inactivation tank



Two-tank inactivation system

CENTRIFUGE

The main products of the centrifuge are: high-speed tubular centrifuge series, refrigerated centrifuge series, peristaltic pump series and other products. With reliable quality and excellent performance, the products are widely used in pharmaceutical, biological products, blood products, chemical industry, food and beverage and other industries. Users are welcome to conduct various technical consultations. For the equipment purchased by users, the company is responsible for installation and commissioning, on-site guidance and training, until it is put into production.

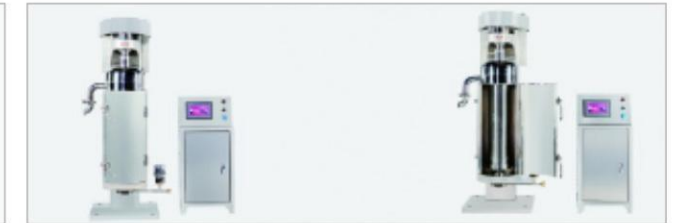

Main technical parameters

Model	Separation factor (xg)	Drum inner diameter (mm)	Drum length (mm)	Drum volume (L)	Rotating speed (r/min)	Water flow (m ³ /h)	Motor Power (Kw)	Weight (Kg)
JM-2	17000	76	430	2	20000	0.2	1.5	180
JM-6	15000	105	730	6	16000	1.2	3	550
JM-6T	15000	105	730	6	16000	1.2	3	550
JM-6F	15000	105	730	6	16000	1.2	3	550
JM-11	15900	142	820	10	14000	1.5	3	550
JM-11FC	20000	142	820	11	16000	2	3	900